

## Chapters SPS 320 to 325 Appendix A

### UDC Appendix Table of Contents

Chapter 320	
Dwelling Separations	92
Model Ordinance	93
Sample Forms	95
Sanitary Permit Requirements	105
Chapter 321	
Use of Span & Species Tables	106
Span & Species Tables	113
Handrail Diagrams	139
Erosion & Sediment Control Procedures & Standards	140
Frost-Protected Shallow Foundations	225
HUD Roof-Load Zone Map	229
Chapter 322	
Slab-On-Grade Insulation Details	230
Chapter 323	
Outdoor Design Temperatures	231

**320.04 (6) – Dwelling Separations**

Normally, for 3 or more attached dwelling units, the Commercial Building Code (CBC) applies. Attached means some construction (other than footings and their bearing material) is shared by the units.

Where 3 or more adjacent but unattached dwelling units are each built with the outside walls that comply with the Uniform Dwelling Code (UDC), the UDC applies throughout and the CBC does *not* apply, even if those outside walls are adjacent to or adjoin each other. If flashing is added over the top of two such adjoining walls, the UDC would still apply.

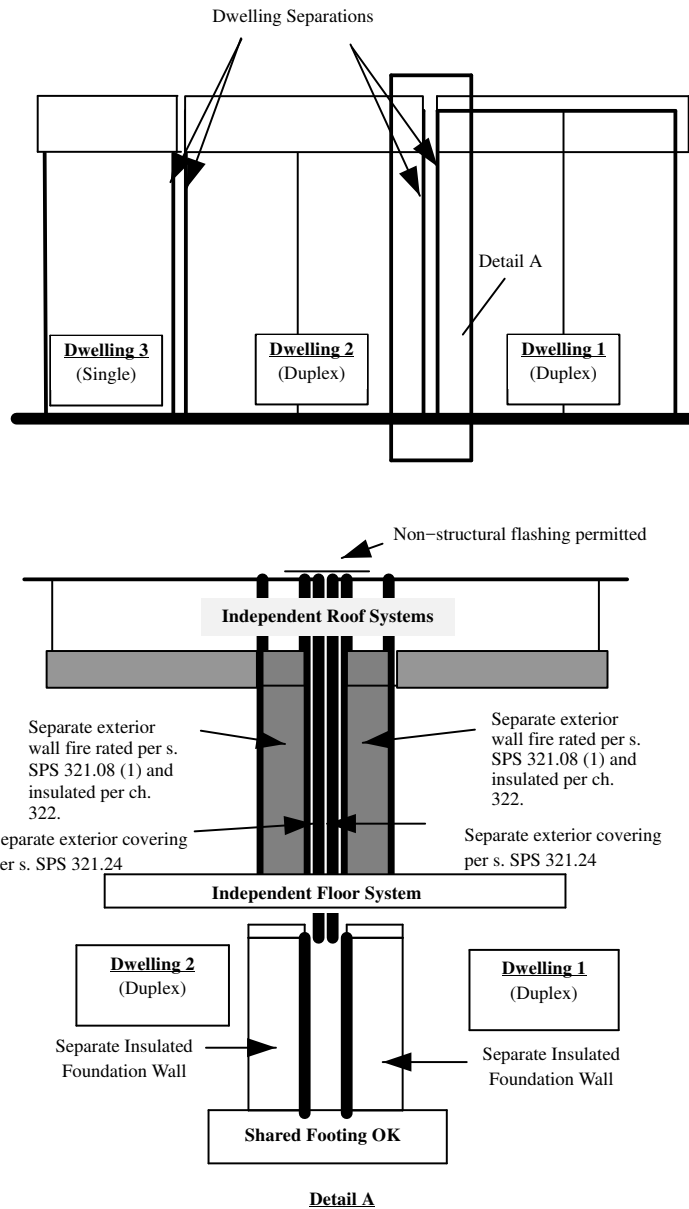

## Model Ordinance for Adoption of Wisconsin Uniform Dwelling Code

It is intended that this model will assist local jurisdictions, working with corporation counsel, through regular procedures, in adopting a local ordinance. The Wisconsin Division of Industry Services also offers an electronic version of this model ordinance and a more comprehensive model building code on our website at <http://dsps.wi.gov/programs/industry-services>, on the One- and Two-Family (Uniform Dwelling Code) program page. Upon adoption of a new building code, send a certified copy to the Division of Industry Services, P.O. Box 2658, Madison, WI 53701-2658, or fax it to (608) 283-7457, along with the name of your certified inspector(s).

Town, Village, City, County of \_\_\_\_\_.

### ORDINANCE #

### CONTENTS

- 1.1 Authority
- 1.2 Purpose
- 1.3 Scope
- 1.4 Adoption of Wisconsin Uniform Dwelling Code
- 1.5 Building Inspector
- 1.6 Building Permit Required
- 1.7 Building Permit Fees
- 1.8 Penalties
- 1.9 Effective Date

1.1 **AUTHORITY.** These regulations are adopted under the authority granted by s. 101.65, Wisconsin Statutes

**[IF COUNTY ORDINANCE]** This ordinance shall apply in any municipality of over 2,500 population without a Uniform Dwelling Code enforcement program and the following other municipalities requesting county enforcement: \_\_\_\_\_ and in the following other municipalities that the Wisconsin Department of Safety and Professional Services has delegated enforcement to our county \_\_\_\_\_.

1.2 **PURPOSE.** The purpose of this ordinance is to promote the general health, safety and welfare and to maintain required local uniformity with the administrative and technical requirements of the Wisconsin Uniform Dwelling Code.

1.3 **SCOPE.** The scope of this ordinance includes the construction and inspection of one- and two-family dwellings built since June 1, 1980.

**[OPTIONAL]** Notwithstanding s. SPS 320.05, the scope also includes the construction and inspection of alterations and additions to one- and two-family dwellings built before June 1, 1980. Because such projects are not under state jurisdiction, petitions for variance and final appeals under ss. SPS 320.19 and 320.21, respectively, shall be decided by the municipal board of appeals. Petitions for variance shall be decided per s. SPS 320.19 (intro.) so that equivalency is maintained to the intent of the rule being petitioned. As the board of appeals approves petitions for variance, the chief inspector is granted the power to apply the results to similar circumstances by precedent.

**[OPTIONAL]** Notwithstanding s. SPS 320.05, the scope also includes the construction and inspection of detached garages serving one and two family dwellings. The building structure and any heating, electrical or plumbing systems shall comply with the Uniform Dwelling Code. Petitions for variance and appeals shall be handled as in the previous paragraph.

1.4 **WISCONSIN UNIFORM DWELLING CODE ADOPTED.** The Wisconsin Uniform Dwelling Code, Chs. SPS 320-325 of the Wisconsin Administrative Code, and all amendments thereto, is adopted and incorporated by reference and shall apply to all buildings within the scope of this ordinance.

1.5 **BUILDING INSPECTOR.** There is hereby created the position of Building Inspector, who shall administer and enforce this ordinance and shall be certified by the Department of Safety and Professional Services, as specified by Wisconsin Statutes, Section 101.66 (2), in the category of Uniform Dwelling Code Construction Inspector. Additionally, this or other assistant inspectors shall possess the certification categories of UDC HVAC, UDC Electrical, and UDC Plumbing. (**NOTE:** Contact the Department of Safety and Professional Services at (608) 261-8500 for certification information.)

1.6 **BUILDING PERMIT REQUIRED.** If a person alters a building in excess of **[INSERT AMOUNT]** \$ \_\_\_\_\_ value in any 12-month period, adds onto a building in excess of **[INSERT VALUE or AREA AMOUNT]** \_\_\_\_\_ in any

12-month period, or builds or installs a new building, within the scope of this ordinance, they shall first obtain a building permit for such work from the building inspector. Any structural changes or major changes to mechanical systems that involve extensions shall require permits if over the foregoing thresholds. Restoration or repair of an installation to its previous code-compliant condition as determined by the building inspector is exempted from permit requirements. Residing, re-roofing, finishing of interior surfaces and installation of cabinetry shall be [CHOOSE OPTION] included/exempted from permit requirements.

(NOTE: Fill in the threshold amount above which permits are required. Also decide whether new interior and exterior surfaces or cabinetry shall be included or exempted.)

1.7 BUILDING PERMIT FEE. The building permit fees shall be determined by resolution and shall include \$25.00 to be forwarded to the Wisconsin Department of Safety and Professional Services for a UDC permit seal that shall be assigned to any new dwelling.

1.8 PENALTIES. The enforcement of this section and all other laws and ordinances relating to building shall be by means of the withholding of building permits, imposition of forfeitures and injunctive action. Forfeitures shall be not less than \$25.00 nor more than \$1,000.00 for each day of noncompliance.

1.9 EFFECTIVE DATE. This ordinance shall be effective \_\_\_\_\_, upon passage and publication as provided by law.

1.10 The building inspector(s) shall keep a log of all inspections completed.

Adopted this \_\_\_\_\_, day of \_\_\_\_\_,

\_\_\_\_\_  
(Mayor, President, Chairperson)

Attest: \_\_\_\_\_

Published: \_\_\_\_\_

Dept of Safety & Professional Services Industry Services Division Wisconsin Stats. 101.63, 101.73	<h2 style="margin: 0;">Wisconsin Uniform Building Permit Application</h2> <p style="font-size: small; margin: 0;"><b>Instructions on back of second ply.</b> The information you provide may be used by other government agency programs [(Privacy Law, s. 15.04 (1)(m))]</p>	Application No.  Parcel No.																					
<b>PERMIT REQUESTED</b> <input type="checkbox"/> Constr. <input type="checkbox"/> HVAC <input type="checkbox"/> Electric <input type="checkbox"/> Plumbing <input type="checkbox"/> Erosion Control <input type="checkbox"/> Other:																							
Owner's Name		Mailing Address																					
Contractor Name & Type		Lic/Cert#																					
Dwelling Contractor (Constr.)		Mailing Address																					
Dwelling Contr. Qualifier		The Dwelling Contr. Qualifier shall be an owner, CEO, COB or employee of the Dwelling Contr.																					
HVAC																							
Electrical																							
Plumbing																							
<b>PROJECT LOCATION</b>	Lot area Sq.ft.	<input type="checkbox"/> One acre or more of soil will be disturbed <input type="checkbox"/> Town <input type="checkbox"/> Village <input type="checkbox"/> City of _____ 1/4, _____ 1/4, of Section _____, T _____ N, R _____ E/W																					
Building Address		County																					
		Subdivision Name																					
		Lot No.																					
		Block No.																					
Zoning District(s)	Zoning Permit No.	<b>Setbacks:</b> Front ft.    Rear ft.    Left ft.    Right ft.																					
<b>1. PROJECT</b>																							
<input type="checkbox"/> New <input type="checkbox"/> Repair <input type="checkbox"/> Single Family <input type="checkbox"/> Alteration <input type="checkbox"/> Raze <input type="checkbox"/> Two Family <input type="checkbox"/> Addition <input type="checkbox"/> Move <input type="checkbox"/> Garage <input type="checkbox"/> Other: _____																							
<b>3. OCCUPANCY</b>																							
<input type="checkbox"/> Single Family <input type="checkbox"/> Two Family <input type="checkbox"/> Garage <input type="checkbox"/> Other: _____																							
<b>6. ELECTRIC</b>																							
Entrance Panel Amps: _____ <input type="checkbox"/> Underground <input type="checkbox"/> Overhead																							
<b>9. HVAC EQUIP.</b>																							
<input type="checkbox"/> Furnace <input type="checkbox"/> Radiant Basebd <input type="checkbox"/> Heat Pump <input type="checkbox"/> Boiler <input type="checkbox"/> Central AC <input type="checkbox"/> Fireplace <input type="checkbox"/> Other: _____																							
<b>12. ENERGY SOURCE</b>																							
<table style="width:100%; border-collapse: collapse;"> <tr> <td style="width:15%;">Fuel</td> <td style="width:10%;">Nat Gas</td> <td style="width:10%;">LP</td> <td style="width:10%;">Oil</td> <td style="width:10%;">Elec</td> <td style="width:10%;">Solid</td> <td style="width:10%;">Solar Geo</td> </tr> <tr> <td>Space Htg</td> <td><input type="checkbox"/></td> <td><input type="checkbox"/></td> <td><input type="checkbox"/></td> <td><input type="checkbox"/></td> <td><input type="checkbox"/></td> <td><input type="checkbox"/></td> </tr> <tr> <td>Water Htg</td> <td><input type="checkbox"/></td> <td><input type="checkbox"/></td> <td><input type="checkbox"/></td> <td><input type="checkbox"/></td> <td><input type="checkbox"/></td> <td><input type="checkbox"/></td> </tr> </table>			Fuel	Nat Gas	LP	Oil	Elec	Solid	Solar Geo	Space Htg	<input type="checkbox"/>	<input type="checkbox"/>	<input type="checkbox"/>	<input type="checkbox"/>	<input type="checkbox"/>	<input type="checkbox"/>	Water Htg	<input type="checkbox"/>	<input type="checkbox"/>	<input type="checkbox"/>	<input type="checkbox"/>	<input type="checkbox"/>	<input type="checkbox"/>
Fuel	Nat Gas	LP	Oil	Elec	Solid	Solar Geo																	
Space Htg	<input type="checkbox"/>	<input type="checkbox"/>	<input type="checkbox"/>	<input type="checkbox"/>	<input type="checkbox"/>	<input type="checkbox"/>																	
Water Htg	<input type="checkbox"/>	<input type="checkbox"/>	<input type="checkbox"/>	<input type="checkbox"/>	<input type="checkbox"/>	<input type="checkbox"/>																	
<b>2. AREA INVOLVED (sq ft)</b>																							
	Unit 1	Unit 2																					
Unfin. Bsmt																							
Living Area																							
Garage																							
Deck/Porch																							
Totals																							
<b>4. CONST. TYPE</b>																							
<input type="checkbox"/> Site-Built <input type="checkbox"/> Mfd. per WI UDC <input type="checkbox"/> Mfd. per US HUD																							
<b>7. WALLS</b>																							
<input type="checkbox"/> Wood Frame <input type="checkbox"/> Steel <input type="checkbox"/> ICF <input type="checkbox"/> Timber/Pole <input type="checkbox"/> Other: _____																							
<b>5. STORIES</b>																							
<input type="checkbox"/> 1-Story <input type="checkbox"/> 2-Story <input type="checkbox"/> Other: _____ <input type="checkbox"/> Plus Basement																							
<b>8. USE</b>																							
<input type="checkbox"/> Seasonal <input type="checkbox"/> Permanent <input type="checkbox"/> Other: _____																							
<b>10. SEWER</b>																							
<input type="checkbox"/> Municipal <input type="checkbox"/> Sanitary Permit# _____																							
<b>11. WATER</b>																							
<input type="checkbox"/> Municipal <input type="checkbox"/> On-Site Well																							
<b>13. HEAT LOSS</b>																							
_____ BTU/HR Total Calculated Envelope and Infiltration Losses (available from "Total Building Heating Load" on Rescheck report)																							
<b>14. EST. BUILDING COST w/o LAND</b>																							
\$ _____																							
I understand that I: am subject to all applicable codes, laws, statutes and ordinances, including those described on the reverse side of the last ply of this form; am subject to any conditions of this permit; understand that the issuance of this permit creates no legal liability, express or implied, on the state or municipality; and certify that all the above information is accurate. If one acre or more of soil will be disturbed, I understand that this project is subject to ch. NR 151 regarding additional erosion control and stormwater management and the owner shall sign the statement on the back of the permit if not signing below. I expressly grant the building inspector, or the inspector's authorized agent, permission to enter the premises for which this permit is sought at all reasonable hours and for any proper purpose to inspect the work which is being done. <input type="checkbox"/> I vouch that I am or will be an owner-occupant of this dwelling for which I am applying for an erosion control or construction permit without a Dwelling Contractor Certification and have read the cautionary statement regarding contractor responsibility on the reverse side of the last ply of this form.																							
<b>APPLICANT (Print):</b> _____ <b>Sign:</b> _____ <b>DATE</b> _____																							
<b>APPROVAL CONDITIONS</b> This permit is issued pursuant to the following conditions. Failure to comply may result in suspension or revocation of this permit or other penalty. <input type="checkbox"/> See attached for conditions of approval.																							
<b>ISSUING JURISDICTION</b> <input type="checkbox"/> Town of <input type="checkbox"/> Village of <input type="checkbox"/> City of <input type="checkbox"/> County of <input type="checkbox"/> State →    State-Contracted Inspection Agency#: _____    Municipality Number of Dwelling Location: _____																							
<b>FEES:</b>																							
Plan Review	\$ _____	<b>PERMIT(S) ISSUED</b> <input type="checkbox"/> Construction <input type="checkbox"/> HVAC <input type="checkbox"/> Electrical <input type="checkbox"/> Plumbing <input type="checkbox"/> Erosion Control																					
Inspection	\$ _____																						
Wis. Permit Seal	\$ _____																						
Other	\$ _____																						
Total	\$ _____																						
		<b>WIS PERMIT SEAL #</b> _____																					
<b>PERMIT ISSUED BY:</b>																							
Name _____																							
Date _____ Tel. _____																							
Cert No. _____																							

SBD-5823(R06/14) Distribute:  Ply 1 – Issuing Jurisdiction;  Ply 2- Issuer forwards to state w/in 30 days;  Ply 3- Inspector;  Ply 4- Applicant

## INSTRUCTIONS

The owner, builder or agents shall complete the application form down through the Signature of Applicant block and submit it and building plans and specifications to the enforcing jurisdiction, which is usually your municipality or county. Permit application data is used for statewide statistical gathering on new one- and two-family dwellings, as well as for local code administration.

**Please type or use ink and press firmly with multi-ply form.**

## PERMIT REQUESTED

- Check off type of Permit Requested, such as structural, HVAC, Electrical or Plumbing.
- Fill in owner's current Mailing Address and Telephone Number.
- If the project will disturb one acre or more of soil, the project is subject to the additional erosion control and stormwater provisions of ch. NR 151 of the WI Administrative Code. Checking this box will satisfy the related notification requirements of ch. NR 216.
- Fill in Contractor and Contractor Qualifier Information. Per s. 101.654 (1) WI Stats., an individual taking out an erosion control or construction permit shall enter his or her dwelling contractor certificate number, and name and certificate number of the dwelling contractor qualifier employed by the contractor, unless they reside or will reside in the dwelling. Per s. 101.63 (7) Wis. Stats., the master plumber name and license number must be entered before issuing a plumbing permit.

## PROJECT LOCATION

- Fill in Building Address (number and street or sufficient information so that the building inspector can locate the site).
- Local zoning, land use and flood plain requirements must be satisfied before a building permit can be issued. County approval may be necessary.
- Fill in Zoning District, lot area and required building setbacks.

PROJECT DATA — Fill in all numbered project data blocks (1–14) with the required information. All data blocks must be filled in, including the following:

2. Area (involved in project):
  - Basements — include unfinished area only
  - Living area — include any finished area including finished areas in basements
  - Two-family dwellings — include separate and total combined areas
3. Occupancy — Check only “Single-Family” or “Two-Family” if that is what is being worked on. In other words, do not check either of these two blocks if only a new detached garage is being built, even if it serves a one or two family dwelling. Instead, check “Garage” and number of stalls. If the project is a community based residential facility serving 3 to 8 residents, it is considered a single-family dwelling.
9. HVAC Equipment — Check only the major source of heat, plus central air conditioning if present. Only check “Radiant Baseboard” if there is no central source of heat.
10. Plumbing — A building permit cannot be issued until a sanitary permit has been issued for any new or affected existing private onsite wastewater treatment system.
14. Estimated Cost — Include the total cost of construction, including materials and market rate labor, but not the cost of land or landscaping.

SIGNATURE — The owner or the contractor's authorized agent shall sign and date this application form. If you do not possess the Dwelling Contractor certification, then you will need to check the owner-occupancy statement for any erosion control or construction permits.

CONDITIONS OF APPROVAL — The authority having jurisdiction uses this section to state any conditions that must be complied with pursuant to issuing the building permit.

ISSUING JURISDICTION: This must be completed by the authority having jurisdiction.

- Check off Jurisdiction Status, such as town, village, city, county or state and fill in Municipality Name
- Fill in State Inspection Agency number only if working under state inspection jurisdiction.
- Fill in Municipality Number of Dwelling Location
- Check off type of Permit Issued, such as construction, HVAC, electrical or plumbing.
- Fill in Wisconsin Uniform Permit Seal Number, if project is a new one- or two-family dwelling.
- Fill in Name and Inspector Certification Number of person reviewing building plans and date building permit issued.

INSPECTORS: PLEASE RETURN SECOND PLY WITHIN 30 DAYS AFTER ISSUANCE TO (You may fold along the dashed lines and insert this form into a window envelope.):

Industry Services Division  
PO Box 7302  
Madison WI 53707-7302

(Part of Ply 4 for Applicants)

**Cautionary Statement to Owners Obtaining Building Permits**

101.65(lr) of the Wisconsin Statutes requires municipalities that enforce the Uniform Dwelling Code to provide an owner who applies for a building permit with a statement advising the owner that:

If the owner hires a contractor to perform work under the building permit and the contractor is not bonded or insured as required under s. 101.654 (2) (a), the following consequences might occur:

(a) The owner may be held liable for any bodily injury to or death of others or for any damage to the property of others that arises out of the work performed under the building permit or that is caused by any negligence by the contractor that occurs in connection with the work performed under the building permit.

(b) The owner may not be able to collect from the contractor damages for any loss sustained by the owner because of a violation by the contractor of the one- and two- family dwelling code or an ordinance enacted under sub. (1) (a), because of any bodily injury to or death of others or damage to the property of others that arises out of the work performed under the building permit or because of any bodily injury to or death of others or damage to the property of others that is caused by any negligence by the contractor that occurs in connection with the work performed under the building permit.

**Cautionary Statement to Contractors for Projects Involving Building Built Before 1978**

If this project is in a dwelling or child-occupied facility, built before 1978, and disturbs 6 sq. ft. or more of paint per room, 20 sq. ft. or more of exterior paint, or involves windows, then the requirements of ch. DHS 163 requiring Lead-Safe Renovation Training and Certification apply. Call (608)261-6876 or go to the Wisconsin Department of Health Services' lead homepage for details of how to be in compliance

**Wetlands Notice to Permit Applicants**

You are responsible for complying with state and federal laws concerning the construction near or on wetlands, lakes, and streams. Wetlands that are not associated with open water can be difficult to identify. Failure to comply may result in removal or modification of construction that violates the law or other penalties or costs. For more information, visit the Department of Natural Resources wetlands identification web page or contact a Department of Natural Resources service center.

**Additional Responsibilities for Owners of Projects Disturbing One or More Acre of Soil**

I understand that this project is subject to ch. NR 151 regarding additional erosion control and stormwater management and will comply with those standards.

Owner's Signature: \_\_\_\_\_

**Contractor Credential Requirements**

All contractors shall possess an appropriate contractor credential issued by the Wisconsin Division of Industry Services. Contractors are also required to only subcontract with contractors that hold the appropriate contractor credentials.

Work shall not proceed until the inspector has approved the various stages of construction or two business days have elapsed since the day of inspection request. This permit will expire 24 months after the date of issuance if the building's exterior has not been completed. **Keep this card posted until final inspection has been made.** (WI Stats. 101.63)

**WISCONSIN UNIFORM**

**BUILDING PERMIT #**

Affix uniform permit seal here (when applicable)  
Seal No. \_\_\_\_\_

Constr  HVAC  Elect  Plumb  Erosion

**Project:** \_\_\_\_\_

SITE INFO	
SUBDIVISION _____	NO. _____
LOT NO. _____ BLOCK _____	
ZONING DISTRICT _____	
_____/4, SEC. _____, T. _____, N, R. _____ E or W	
PARCEL NO. _____	
SETBACKS: _____ ft REAR _____ ft	
FRONT _____ ft	
LEFT _____ ft RIGHT _____ ft	

PHASE	INSPECTIONS		EROSION
	ROUGH	FINAL	
FOOTING			
FOUNDATION			
BSMT DRAIN TILES			
CONSTRUCTION			
PLUMBING			
HEAT/VENT/AC			
ELECTRICAL			
INSULATION			
OCCUPANCY			

<b>Issued To</b>	OWNER (AGENT)	PHONE
	BUILDING SITE ADDRESS	
	CITY, VILLAGE, TOWN	

<b>Issued by</b>	PERSON ISSUING	CERT. NO.
	DATE ISSUED	TELEPHONE

**Comments:** \_\_\_\_\_

CONTRACTORS		
NAME	CREDENTIAL #	PHONE
G.C.		
HVAC		
ELECT.		
PLBG		

**NOTICE OF NONCOMPLIANCE:** This issuing jurisdiction shall notify the applicant in writing of any violations to be corrected. All cited violations, except erosion control ones, shall be corrected within 30 days of notification, unless extension time is granted.

SBD-5824 (R11/11)



DO NOT REMOVE  
OFFICIAL NOTICE

Location/Item: \_\_\_\_\_

Lacking \_\_\_\_\_ Permit(s)  Need \_\_\_\_\_ Inspection

Expired \_\_\_\_\_ Permit  Premises Housekeeping

Unfit for Use

Erosion Control:  Perimeter Measures  Install  Maintain  
 Non-Tracking Driveway  Install  Maintain  
 Sediment Cleanup  Street & Sidewalks  Adjoining Property

Code Section/Other: \_\_\_\_\_

**Action:**

Contact Inspector  Now  After Corrections

Correct  Now  By End Of Today (UDC Tracking Cleanup)  
 By End Of Next Workday (UDC Sediment Cleanup)  
 In 48 Hrs (UDC Erosion Controls)  By \_\_\_\_\_

Stop All Work  Except Corrections Code Section: \_\_\_\_\_

**Failure To Comply Subjects You To Applicable Fines & Penalties or Work Stoppages**

Inspector/Agency \_\_\_\_\_ Phone Number \_\_\_\_\_ Date \_\_\_\_\_

SBD-10266 (R.6/07)



**STATE OF WISCONSIN**  
Department of Safety and  
Professional Services

## Application for Review, Petition for Variance

-Complete all pages-

Industry Services Division

NOTE: Personal information you provide may be used for secondary purposes [Privacy Law s. 15.04(1) (m), Stats.]

Use this page for fax appointments (fax 877-840-9172)

Indicate date plans will be in Industry Services office \_\_\_\_\_

<b>1. Facility Information</b>  Facility (Building) Name: _____ Number and Street _____ Zip: _____ SPS Site Number (if known): _____ Legal Description: _____ County of: _____ <input type="checkbox"/> City <input type="checkbox"/> Village <input type="checkbox"/> Town of: _____		<b>Complete for <u>confirmed</u> appointments*:</b>  Transaction ID: _____ Previous Related Trans. ID: _____ Assigned Reviewer: _____ Assigned Office: _____ Review Start Date*: _____ *Submittal must be received in the office of the appointment no later than <b>two working days before the confirmed appointment.</b>	
<b>2. Owner Information</b> Name _____ Company Name _____ Number and Street _____ City, State, Zip Code _____ Contact Person _____ Telephone Number _____ Fax Number _____	<b>Customer #</b> _____	<b>3. Designer Information</b> Designer _____ Design Firm _____ Number and Street _____ City, State, Zip Code _____ Contact Person _____ Telephone Number _____ Fax Number _____	<b>Customer #</b> _____

**4. Plan Review Status**

Plan submitted with petition  
 Plan will be submitted after petition determination  
 Requesting revision     Other: \_\_\_\_\_  
 SPS Transaction Number \_\_\_\_\_

**Plan previously review by (please enclose a copy of review letter)**

State     Municipality     Approved     Held     Denied  
**Code Being Petitioned**     Commercial Building     HVAC     Plumbing  
 Private Sewage System     Swimming Pool     Electrical     Flammable Liquids  
 Amusement Rides     Uniform Dwelling Code     Boilers     Elevators  
 Gas Systems     Refrigeration     Rental Weatherization     Other: \_\_\_\_\_

5. State the code section being petitioned AND the specific condition or issue you are requesting be covered under this petition for variance.  
\_\_\_\_\_
6. Reason why compliance with the code cannot be attained without the variance (Attach additional sheets, if necessary)  
\_\_\_\_\_
7. State your proposed means and rationale of providing equivalent degree of health, safety, or welfare as addressed by the code section petitioned.  
\_\_\_\_\_
8. List attachments to be considered as part of the petitioner's statements (i.e., model code sections, test reports, research articles, expert opinion, previously approved variances, pictures, plans, sketches, etc.).  
\_\_\_\_\_

**Verification by Owner - Petition is Valid Only if Notarized with Affixed Seal and Accompanied by Review Fee**  
 Note: Petitioner must be the owner of the building or system or credential applicant for a SPS 305 petition. Tenants, agents, designers, contractors, attorneys, etc., shall not sign petition unless Power of Attorney is submitted with the Petition for Variance Application.

\_\_\_\_\_, being duly sworn, I state as petitioner that I have read the foregoing petition and I believe it is true and that I have significant ownership rights to the subject building or project.

Petitioner's Signature _____	Subscribed and sworn to before me this date _____	Notary Public _____	My commission expires on _____
------------------------------	---	---------------------	--------------------------------

<b>Make Checks Payable to: State of WI – DSPS or</b> <input type="checkbox"/> Invoice Designer, who will be personally responsible for payment. Designer: _____ Signature _____	Total Amount Due \$ _____ Attach check here.
--	---

Owner's Name _____	Project Location _____	Plan Number _____
--------------------	------------------------	-------------------

(R07-14)

Page 2 of \_\_\_\_\_

## Fire Department Position Statement

To be completed for fire or life–safety related variances requested from SPS 361–66, SPS 316, and other fire–related requirements.

**I have read the application for variance and recommend:** (check appropriate box)

Approval                       Conditional Approval                       Denial                       No Comment

Explanation for recommendation including any conflicts with local rules and regulations and suggested conditions:

---



---



---



---

Fire Department Name and Address
----------------------------------

Name of Fire Chief or Designee (type or print)	Telephone Number
--	------------------

Signature of Fire Chief or Designee	Date Signed
-------------------------------------	-------------

## Municipal Buildings Inspection Recommendation

To be completed for variances requested from SPS 320–323. Also to be used for SPS 316 electrical petitions, if SPS 361–366 plan review is by municipality or orders are written on the building under construction; optional in other cases.  
Please submit a copy of the orders.

**I have read the application for variance and recommend:** (check appropriate box)

Approval                       Conditional Approval                       Denial                       No Comment

Explanation for recommendation including any conflicts with local rules and regulations and suggested conditions:

---



---



---



---

Municipality Exercising Jurisdiction
--------------------------------------

Name and Address of Municipal Official (type or print)	Telephone Number of Enforcement Official
--	--

Signature of Municipal Enforcement Official	Date Signed
---	-------------

Industry Services Division

## Petition for Variance Information and Instructions SPS 303

In instances where exact compliance with a particular code requirement cannot be met or alternative designs are desired, the division has a petition for variance process in which it reviews and considers acceptance of alternatives which are not in strict conformance with the letter of the code, but which meet the intent of the code. **A variance is not a waiver from a code requirement.** The petitioner must **provide an equivalency which meets the intent** of the code section petitioned to obtain a variance. Documentation of the rationale for the equivalency is required. Failure to provide adequate information may delay a decision on the petition. Pictures, sketches, and plans may be submitted to support equivalency. If the proposed equivalency does not adequately safeguard the health, safety, and welfare of building occupants, frequenters, firefighters, etc., the variance request will be denied. **NOTE: A SEPARATE PETITION IS REQUIRED FOR EACH BUILDING AND EACH CODE ISSUE PETITIONED** (i.e., window issue cannot be processed on the same petition as stair issue). It should be noted that **a petition for variance does not take the place of any required plan review submittal.**

The division is unable to process petitions for variance that are not properly completed. Before submitting the application, the following items should be checked for completeness in order to avoid delays:

- Petitioner's name (typed or printed)
- Petitioner's signature
- The application must be signed by the owner of the building or system unless a Power of Attorney is submitted.
- Notary Public signature with affixed seal
- Analysis to establish equivalency, including any pictures, illustrations or sketches of the existing and proposed conditions to clearly convey your proposal to the reviewer.
- Proper fee
- Any required position statements by fire chief or municipal official

A position statement from the chief of the local fire department is required for fire or life-safety issues. No fire department position statement is required for topics such as plumbing, private onsite sewage systems, or energy conservation. Submit a municipal building inspection department position for SPS 316 electrical petitions, or if SPS 361–366 commercial building plan review is by the municipality or orders are written on the building under construction. (Submit a copy of the orders.) For rules relating to one- and two-family dwellings, only a position statement is required only if the local municipality is the enforcing body. Position statements must be completed and signed by the appropriate fire chief or municipal enforcement official. Signatures or seals on all documents must be originals. Photocopies are not acceptable.

**Contact numbers and fees for the division's review of the petition for variance are as follows:**

Chapter	(circle appropriate category)	Revenue Code	Review Office	Contact Number	Fee	*Revision Fee
SPS 316, Electrical		7631	Waukesha	(262)548-8606	\$300	\$100
SPS 318, Elevators		8260	Waukesha	(262) 521-5444	\$300	\$100
SPS 320-325 Uniform Dwelling Code		7655	Madison	(608) 267-5113	\$175	\$50
SPS 334, Amusement Rides		8266	Madison	(608) 267-4434	\$300	\$100
SPS 340, Gas Systems		8258	Waukesha	(262) 548-8617	\$300	\$100
SPS 341 Boilers and Pressure Vessels		8258	Waukesha	(262) 548-8617	\$300	\$100
SPS 343, Anhydrous Ammonia		8258	Waukesha	(262) 548-8617	\$300	\$100
SPS 345, Mechanical Refrigeration		8258	Waukesha	(262) 548-8617	\$300	\$100
SPS 360-366, Commercial Building Code		7648	All Offices	See Numbers Below	\$550	\$100
(For fire system Petitions for Variance – Contact the Green Bay or Waukesha offices)						
SPS 367, Rental Unit Energy Efficiency Code		7646	Madison	(608) 267-2240	\$175	\$50
SPS 381-387, General Plumbing		7657	All Offices	See Numbers Below	\$300	\$75
SPS 390, Swimming Pools		7650	Madison	(608) 267-5265	\$300	\$75
SPS 383 POWTS		7657	All Offices	See Numbers Below	\$300	\$75
All Other Chapters					\$300	\$100

\*Revisions are accepted only for one year after action on original petition.

**Priority Review:** The department will schedule Petitions for Variance at the earliest available date, or the date requested at time of scheduling, whichever is later. Therefore, priority reviews are not generally available. In special circumstances, the section chief of the reviewing office may permit review prior to the scheduled date upon request by the submitter. If earlier review is permitted by the section chief, the petition review fees will be doubled.

Except for special cases, Industry Services will review and make a determination on a petition for variance within 30 business days of the scheduled beginning date, provided all calculations, documents, and fees required for the review have been received.

**Appointment and Scheduling Information**

It is strongly recommended that an appointment be made in advance by fax. Industry Services has a 24-hour, toll free number dedicated to receiving faxed plan review appointment requests. The dedicated fax number is 877-840-9172. The petition review will be scheduled with the same office where the plan was/will be reviewed. The submitter will receive a letter back with an appointment date, transaction ID number, and the name of the assigned reviewer. The petition and accompanying documents must be received in the office of the appointment no later than two working days before the confirmed appointment. Unscheduled submittals or submittals received without a confirmed appointment date and transaction number may be assigned to offices other than the receiving office depending on reviewer availability. Some petitions may be limited to specific offices depending on the petition issues, see above table for appropriate offices.

Madison – Industry Services	Hayward - Industry Services	La Crosse Area – Industry Services	Green Bay – Industry Services	Waukesha – Industry Services
1400 E Washington Ave Madison, WI 53703	10541N Ranch Rd Hayward WI 54843	3824 Creekside La Holmen WI 54636	2331 San Luis Place Green Bay, WI 54304	141 NW Barstow St 4 <sup>th</sup> Floor Waukesha WI 53188-3789
PO Box 7162 Madison WI 53707-7162	715-634-4870	608-785-9334	920-492-5601	262-548-8600
608-266-3151	Fax: (for sending questions or additional info to reviewers) 715-634-5150	Fax: (for sending questions or additional info to reviewers) 608-785-9330	Fax: (for sending questions or additional info to reviewers) 920-492-5604	Fax: (for sending questions or additional info to reviewers) 262-548-8614
Fax: (for sending questions or additional info to reviewers) 608-267-9566	Email: DspsSbPlanSchedule@wi.gov	Email: DspsSbPlanSchedule@wi.gov	Email: DspsSbPlanSchedule@wi.gov	Email: DspsSbPlanSchedule@wi.gov
TTY: Contact Through Relay				
Email: DspsSbPlanSchedule@wi.gov				

(R07-14)

### SANITARY PERMIT REQUIREMENTS

Section [SPS 320.09 \(9\) \(c\)](#) refers to s. [SPS 383.25 \(2\)](#), which reads as follows:

**SPS 383.25 (2) ISSUANCE OF BUILDING PERMITS.** (a) *General.* Pursuant to s. [145.195](#), Stats., the issuance of building permits by a municipality for unsewered properties shall be in accordance with this subsection.

**Note:** See appendix for a reprint of s. [145.195](#), Stats.

(b) *New construction.* A municipality may not issue a building permit to commence construction or installation of a structure that necessitates the use of a POWTS to serve the structure, unless:

1. The owner of the property possesses a sanitary permit for the installation of a POWTS in accordance with s. [SPS 383.21](#); or

**Note:** Section [SPS 383.21](#) outlines the procedures for the issuance of sanitary permits. Section [145.19](#), Stats., mandates that no private sewage system may be installed unless the owner of the property holds a valid sanitary permit.

2. A POWTS of adequate capability and capacity to accommodate the wastewater flow and contaminant load already exists to serve the structure.

**Note:** See ss. [SPS 383.02](#) and [383.03](#) concerning the application of current code requirements to existing POWTS.

(c) *Construction affecting wastewater flow or contaminant load.* 1. A municipality may not issue a building permit to commence construction of any addition or alteration to an existing structure when the proposed construction will modify the design wastewater flow or contaminant load, or both, to an existing POWTS, unless the owner of the property:

a. Possesses a sanitary permit to either modify the existing POWTS or construct a POWTS to accommodate the modification in wastewater flow or contaminant load, or both; or

b. Provides documentation to verify that the existing POWTS is sufficient to accommodate the modification in wastewater flow or contaminant load, or both.

2. For the purpose of this paragraph, a modification in wastewater flow or contaminant load shall be considered to occur:

a. For commercial facilities, public buildings, and places of employment, when there is a proposed change in occupancy of the structure; or the proposed modification affects either the type or number of plumbing appliances, fixtures or devices discharging to the system; and

b. For dwellings, when there is an increase or decrease in the number of bedrooms.

(d) *Documentation of existing capabilities.* Documentation to verify whether an existing POWTS can accommodate a modification in wastewater flow or contaminant load, or both, shall include at least one of the following:

1. A copy of the plan for the existing POWTS that delineates minimum and maximum performance capabilities and which has been previously approved by the department or the governmental unit.

2. Information on the performance capabilities for the existing POWTS that has been recognized through a product approval under ch. [SPS 384](#).

3. A written investigative report prepared by an architect, engineer, designer of plumbing systems, designer of private sewage systems, master plumber, master plumber–restricted service or certified POWTS inspector analyzing the proposed modification and the performance capabilities of the existing POWTS.

(e) Where the performance capability of the existing POWTS serving a dwelling is not based on the number of bedrooms within the dwelling, information documenting that design condition shall be recorded as a covenant running with the deed for the property.

(f) *Setbacks.* 1. A municipality may not issue a building permit for construction of any structure or addition to a structure on a site where there exists a POWTS, unless the proposed construction conforms to the applicable setback limitations under s. [SPS 383.43 \(8\) \(i\)](#).

2. The applicant for a building permit shall provide documentation to the municipality issuing the building permit showing the location and setback distances for the proposed construction relative to all of the following:

a. Existing POWTS treatment components.

b. Existing POWTS holding components.

c. Existing POWTS dispersal components.

**Note:** A municipality which issues building permits may delegate to the governmental unit responsible for issuing sanitary permits the determination of whether the proposed construction will affect or interfere with an existing POWTS relating to capability or location of the existing POWTS.

### UDC Floor & Ceiling Joist and Roof Rafter Span Tables and Design Value Tables

Use the following Span Tables to determine the maximum spans for floor and ceiling joists and roof rafters. These spans are based on:

- Simple, single spans (although the tables may be safely used for continuous two-span floor joists)
- Uniformly distributed loads
- Fully supported members with one edge properly sheathed and nailed
- For floor joists and roof rafters, the top edge shall be properly sheathed and nailed
- Rafters with a minimum 3:12 slope

The criteria for each Span Table is given in the upper left hand corner and is also summarized in the table of Span Tables below. Choose the appropriate Span Table based on the member type and required loading. Select your desired member depth, member spacing and span to determine the minimum Fb value. Note that these tables include recommended deflection criteria. However, for strict code compliance, only the Fb strength requirements must be satisfied. The modulus of elasticity (E) values, would be met for serviceability purposes only.

Note that straight-line interpolation is permitted for intermediate spans and design values. Span is measured from face to face of supports plus one-half of the required bearing of 1.5" on wood or metal and 3" on masonry or concrete at each end. For sloping rafters, the span is measured along the horizontal projection.

Section [SPS 321.27](#) allows reduction of the snow live load for roof slopes greater than 30 degrees (7/12 slope) based on the formula  $C_s = 1 - (a-30)/40$ , where "a" is the slope of the roof expressed in degrees. Following is a table of tabulated values for certain roof slopes.

Slope	Angle in Degrees	Zone 1 Live Load (psf)	Zone 2 Live Load (psf)
7/12	30	40	30
10/12	40	30	22.5
12/12	45	25	18.8
14/12	50	20	15

Use the Design Value tables following the Span Tables to determine the acceptable species and grades to satisfy minimum Fb values obtained from the Span Tables. The Design Value tables assume at least three members spaced no more than 24" on center. Use the Normal Duration column Fb values for joists and the Snow Loading column Fb values for rafters.

See the following examples for further guidance.

Tables are reprinted courtesy of American Forest & Paper Association.

Table No.	Member Type	Live Load (psf)	Dead Load (psf)	Condition	(Deflection)*
F-2	Floor Joists	40	10	–	L/360
C-1	Ceiling Joists	10	5	Drywall ceiling, no attic storage	L/240
C-2	Ceiling Joists	20	10	Attic storage	L/240
R-2	Roof Rafters	30 (Zone 2)	10	Maximum 2 layers of asphalt shingles or wood shakes/shingles	L/240
R-3	Roof Rafters	40 (Zone 1)	10	Maximum 2 layers of asphalt shingles or wood shakes/shingles	L/240
R-10	Roof Rafters	30 (Zone 2)	20	Heavy roof covering (clay tile)	L/240
R-11	Roof Rafters	40 (Zone 1)	20	Heavy roof covering (clay tile)	L/240
R-14	Roof Rafters	30 (Zone 2)	10	Maximum 2 layers of asphalt shingles or wood shakes/shingles	L/180
R-15	Roof Rafters	40 (Zone 1)	10	Maximum 2 layers of asphalt shingles or wood shakes/shingles	L/180
R-22	Roof Rafters	30 (Zone 2)	20	Heavy roof covering (clay tile)	L/180
R-23	Roof Rafters	40 (Zone 1)	20	Heavy roof covering (clay tile)	L/180

\*Deflection criteria are optional. For roof rafters with drywall on the underside, use the stricter L/240 tables to limit deflection.

**Example 1. Floor Joists.** Assume a required single span of 12'-9", dead load of 10 psf and joists spaced 16" on center. Table F-2 (see following highlighted tables) shows that one solution is a grade of 2x8 having an Fb value of 1255 would allow a span of 12'-10" which satisfies the condition. (Note that the recommended E value to limit deflection would be 1,600,000.) Going to the Design Value Tables, we find that as an example, 2x8 Hem Fir grade No.1 has an Fb value of 1310 for normal duration. (It also has an E value of 1,500,000 which does not satisfy the recommended deflection criteria.)

**Example 2. Rafters.** Assume a horizontal projected span of 13'-0", a live load of 40 psf, dead load of 10 psf, a roof slope of 4/12 and rafters spaced 16" on center. Since the slope is shallower than 7/12, there is no allowable reduction of the snow live load. Table R-3 shows that a 2x8 having an Fb value of 1300 would allow a span of 13'-1" which satisfies the condition. (Note that the recommended E value to limit deflection would be 1,120,000.) Going to the Design Value Tables, we find that as an example, 2x8 Douglas Fir-Larch grade No.2 has an Fb value of 1390 for snow loading. (It also has an E value of 1,600,000 which satisfies the recommended deflection criteria.)

**Example 1**  
**TABLE F-2**  
**FLOOR JOISTS WITH L/360 DEFLECTION LIMITS**

**DESIGN CRITERIA:**

Deflection - For 40 psf live load.

Limited to span in inches divided by 360.

Strength - Live load of 40 psf plus dead load of 10 psf determines the required bending design value.

Joist Size (in)	Spacing (in)	Modulus of Elasticity, E, in 1,000,000 psi																
		0.8	0.9	1.0	1.1	1.2	1.3	1.4	1.5	1.6	1.7	1.8	1.9	2.0	2.1	2.2	2.3	2.4
2x 6	12.0	8-6	8-10	9-2	9-6	9-9	10-0	10-3	10-6	10-9	10-11	11-2	11-4	11-7	11-9	11-11	12-1	12-3
	16.0	7-9	8-0	8-4	8-7	8-10	9-1	9-4	9-6	9-9	9-11	10-2	10-4	10-6	10-8	10-10	11-0	11-2
	19.2	7-3	7-7	7-10	8-1	8-4	8-7	8-9	9-0	9-2	9-4	9-6	9-8	9-10	10-0	10-2	10-4	10-6
	24.0	6-9	7-0	7-3	7-6	7-9	7-11	8-2	8-4	8-6	8-8	8-10	9-0	9-2	9-4	9-6	9-7	9-9
2x 8	12.0	11-3	11-8	12-1	12-6	12-10	13-2	13-6	13-10	14-2	14-5	14-8	15-0	15-3	15-6	15-9	15-11	16-2
	16.0	10-2	10-7	11-0	11-4	11-8	12-0	12-3	12-7	12-10	13-1	13-4	13-7	13-10	14-1	14-3	14-6	14-8
	19.2	9-7	10-0	10-4	10-8	11-0	11-3	11-7	11-10	12-1	12-4	12-7	12-10	13-0	13-3	13-5	13-8	13-10
	24.0	8-11	9-3	9-7	9-11	10-2	10-6	10-9	11-0	11-3	11-5	11-8	11-11	12-1	12-3	12-6	12-8	12-10
2x10	12.0	14-4	14-11	15-5	15-11	16-5	16-10	17-3	17-8	18-0	18-5	18-9	19-1	19-5	19-9	20-1	20-4	20-8
	16.0	13-0	13-6	14-0	14-6	14-11	15-3	15-8	16-0	16-5	16-9	17-0	17-4	17-8	17-11	18-3	18-6	18-9
	19.2	12-3	12-9	13-2	13-7	14-0	14-5	14-9	15-1	15-5	15-9	16-0	16-4	16-7	16-11	17-2	17-5	17-8
	24.0	11-4	11-10	12-3	12-8	13-0	13-4	13-8	14-0	14-4	14-7	14-11	15-2	15-5	15-8	15-11	16-2	16-5
2x12	12.0	17-5	18-1	18-9	19-4	19-11	20-6	21-0	21-6	21-11	22-5	22-10	23-3	23-7	24-0	24-5	24-9	25-1
	16.0	15-10	16-5	17-0	17-7	18-1	18-7	19-1	19-6	19-11	20-4	20-9	21-1	21-6	21-10	22-2	22-6	22-10
	19.2	14-11	15-6	16-0	16-7	17-0	17-6	17-11	18-4	18-9	19-2	19-6	19-10	20-2	20-6	20-10	21-2	21-6
	24.0	13-10	14-4	14-11	15-4	15-10	16-3	16-8	17-0	17-5	17-9	18-1	18-5	18-9	19-1	19-4	19-8	19-11
F <sub>b</sub>	12.0	718	777	833	888	941	993	1043	1092	1140	1187	1233	1278	1323	1367	1410	1452	1494
F <sub>b</sub>	16.0	790	855	917	977	1036	1093	1148	1202	1255	1306	1357	1407	1456	1504	1551	1598	1644
F <sub>b</sub>	19.2	840	909	975	1039	1101	1161	1220	1277	1333	1388	1442	1495	1547	1598	1649	1698	1747
F <sub>b</sub>	24.0	905	979	1050	1119	1186	1251	1314	1376	1436	1496	1554	1611	1667	1722	1776	1829	1882

Note: The required bending design value, F<sub>b</sub>, in pounds per square inch is shown at the bottom of each table and is applicable to all lumber sizes shown. Spans are shown in feet-inches and are limited to 26' and less. Check sources of supply for availability of lumber in lengths greater than 20'.

**Example 1**

Species and Grade	Size	Design Value in Bending, "Fb"		Modulus of Elasticity "E"	Grading Rules Agency	
		Normal Duration	Snow Loading			
<b>Eastern White Pine</b>						
Select Structural	2x4	2155	2480	1,200,000	NELMA NSLB	
No.1		1335	1535	1,100,000		
No.2		990	1140	1,100,000		
No.3		605	695	900,000		
Stud		570	655	900,000		
Construction		775	895	1,000,000		
Standard		430	495	900,000		
Utility		200	230	800,000		
Select Structural		2x6	1870	2150		1,200,000
No.1			1160	1330		1,100,000
No.2	860		990	1,100,000		
No.3	525		600	900,000		
Stud	520		595	900,000		
Select Structural	2x8	1725	1985	1,200,000		
No.1		1070	1230	1,100,000		
No.2		795	915	1,100,000		
No.3		485	555	900,000		
Select Structural	2x10	1580	1820	1,200,000		
No.1		980	1125	1,100,000		
No.2		725	835	1,100,000		
No.3		445	510	900,000		
Select Structural	2x12	1440	1655	1,200,000		
No.1		890	1025	1,100,000		
No.2		660	760	1,100,000		
No.3		405	465	900,000		
<b>Hem Fir</b>						
Select Structural	2x4	2415	2775	1,600,000		WCLIB WWPA
No.1 & Btr		1810	2085	1,500,000		
No.1		1640	1885	1,500,000		
No.2		1465	1685	1,300,000		
No.3		865	990	1,200,000		
Stud		855	980	1,200,000		
Construction		1120	1290	1,300,000		
Standard		635	725	1,200,000		
Utility		290	330	1,100,000		
Select Structural		2x6	2095	2405	1,600,000	
No.1 & Btr	1570		1805	1,500,000		
No.1	1420		1635	1,500,000		
No.2	1270		1460	1,300,000		
No.3	750		860	1,200,000		
Stud	775	895	1,200,000			
Select Structural	2x8	1930	2220	1,600,000		
No.1 & Btr		1450	1665	1,500,000		
No.1		1310	1510	1,500,000		
No.2	2x10	1175	1350	1,300,000		
No.3		690	795	1,200,000		
Select Structural		1770	2035	1,600,000		
No.1 & Btr	2x12	1330	1525	1,500,000		
No.1		1200	1380	1,500,000		
No.2		1075	1235	1,300,000		
No.3		635	725	1,200,000		
Select Structural		1610	1850	1,600,000		
No.1 & Btr	2x12	1210	1390	1,500,000		
No.1		1095	1255	1,500,000		
No.2		980	1125	1,300,000		
No.3		575	660	1,200,000		

**Example 2**  
**TABLE R-3**  
**RAFTERS WITH L/240 DEFLECTION LIMITATION**

**DESIGN CRITERIA:**

Strength - Live Load of 40 psf plus  
 Dead Load of 10 psf determines the required bending design value.  
 Deflection - For 40 psf live load.  
 Limited to span in inches divided by 240.

Size (in)	Spacing (in)	Rafter Bending Design Value, $F_b$ , (psi)																					
		300	400	500	600	700	800	900	1000	1100	1200	1300	1400	1500	1600	1700	1800	1900	2000	2100	2200	2300	2400
2x 6	12.0	5-6	6-4	7-1	7-9	8-5	9-0	9-6	10-0	10-6	11-0	11-5	11-11	12-4	12-8	13-1	13-6	13-10	14-2				
	16.0	4-9	5-6	6-2	6-9	7-3	7-9	8-3	8-8	9-1	9-6	9-11	10-3	10-8	11-0	11-4	11-8	12-0	12-4	12-7	12-11		
	19.2	4-4	5-0	5-7	6-2	6-8	7-1	7-6	7-11	8-4	8-8	9-1	9-5	9-9	10-0	10-4	10-8	10-11	11-3	11-6	11-9	12-0	12-4
	24.0	3-11	4-6	5-0	5-6	5-11	6-4	6-9	7-1	7-5	7-9	8-1	8-5	8-8	9-0	9-3	9-6	9-9	10-0	10-3	10-6	10-9	11-0
2x 8	12.0	7-3	8-4	9-4	10-3	11-1	11-10	12-7	13-3	13-11	14-6	15-1	15-8	16-3	16-9	17-3	17-9	18-3	18-9				
	16.0	6-3	7-3	8-1	8-11	9-7	10-3	10-10	11-6	12-0	12-7	13-1	13-7	14-0	14-6	14-11	15-5	15-10	16-3	16-7	17-0		
	19.2	5-9	6-7	7-5	8-1	8-9	9-4	9-11	10-6	11-0	11-6	11-11	12-5	12-10	13-3	13-8	14-0	14-5	14-10	15-2	15-6	15-10	16-3
	24.0	5-2	5-11	6-7	7-3	7-10	8-4	8-11	9-4	9-10	10-3	10-8	11-1	11-6	11-10	12-2	12-7	12-11	13-3	13-7	13-11	14-2	14-6
2x10	12.0	9-3	10-8	11-11	13-1	14-2	15-1	16-0	16-11	17-9	18-6	19-3	20-0	20-8	21-4	22-0	22-8	23-3	23-11				
	16.0	8-0	9-3	10-4	11-4	12-3	13-1	13-10	14-8	15-4	16-0	16-8	17-4	17-11	18-6	19-1	19-7	20-2	20-8	21-2	21-8		
	19.2	7-4	8-5	9-5	10-4	11-2	11-11	12-8	13-4	14-0	14-8	15-3	15-10	16-4	16-11	17-5	17-11	18-5	18-11	19-4	19-10	20-3	20-8
	24.0	6-6	7-7	8-5	9-3	10-0	10-8	11-4	11-11	12-6	13-1	13-7	14-2	14-8	15-1	15-7	16-0	16-6	16-11	17-4	17-9	18-1	18-6
2x12	12.0	11-3	13-0	14-6	15-11	17-2	18-4	19-6	20-6	21-7	22-6	23-5	24-4	25-2	26-0								
	16.0	9-9	11-3	12-7	13-9	14-11	15-11	16-10	17-9	18-8	19-6	20-3	21-1	21-9	22-6	23-2	23-10	24-6	25-2	25-9			
	19.2	8-11	10-3	11-6	12-7	13-7	14-6	15-5	16-3	17-0	17-9	18-6	19-3	19-11	20-6	21-2	21-9	22-5	23-0	23-6	24-1	24-8	25-2
	24.0	7-11	9-2	10-3	11-3	12-2	13-0	13-9	14-6	15-3	15-11	16-7	17-2	17-9	18-4	18-11	19-6	20-0	20-6	21-1	21-7	22-0	22-6
E	12.0	0.14	0.22	0.31	0.41	0.51	0.63	0.75	0.88	1.01	1.15	1.30	1.45	1.61	1.77	1.94	2.12	2.30	2.48				
E	16.0	0.12	0.19	0.27	0.35	0.44	0.54	0.65	0.76	0.88	1.00	1.12	1.26	1.39	1.54	1.68	1.83	1.99	2.15	2.31	2.48		
E	19.2	0.11	0.18	0.24	0.32	0.41	0.50	0.59	0.69	0.80	0.91	1.03	1.15	1.27	1.40	1.54	1.67	1.81	1.96	2.11	2.26	2.42	2.58
E	24.0	0.10	0.16	0.22	0.29	0.36	0.44	0.53	0.62	0.71	0.81	0.92	1.03	1.14	1.25	1.37	1.50	1.62	1.75	1.89	2.02	2.16	2.30

Note: The required modulus of elasticity, E, in 1,000,000 pounds per square inch is shown at the bottom of each table, is limited to 2.6 million psi and less, and is applicable to all lumber sizes shown. Spans are shown in feet-inches and are limited to 26' and less. Check sources of supply for availability of lumber in lengths greater than 20'.

**Example 2**

Species and Grade	Size	Design Value in Bending, "Fb"		Modulus of Elasticity "E"	Grading Rules Agency	
		Normal Duration	Snow Loading			
<b>Cottonwood</b>						
Select Structural	2x4	1510	1735	1,200,000	NSLB	
No.1		1080	1240	1,200,000		
No.2		1080	1240	1,100,000		
No.3		605	695	1,000,000		
Stud		600	690	1,000,000		
Construction		805	925	1,000,000		
Standard		460	530	900,000		
Utility		200	230	900,000		
Select Structural		2x6	1310	1505		1,200,000
No.1	935		1075	1,200,000		
No.2	935		1075	1,100,000		
No.3	525		600	1,000,000		
Stud	545	630	1,000,000			
Select Structural	2x8	1210	1390	1,200,000		
No.1		865	990	1,200,000		
No.2		865	990	1,100,000		
No.3	485	555	1,000,000			
Select Structural	2x10	1105	1275	1,200,000		
No.1		790	910	1,200,000		
No.2		790	910	1,100,000		
No.3	445	510	1,000,000			
Select Structural	2x12	1005	1155	1,200,000		
No.1		720	825	1,200,000		
No.2		720	825	1,100,000		
No.3	405	465	1,000,000			
<b>Douglas Fir-Larch</b>						
Select Structural	2x4	2500	2875	1,900,000		WCLIB WWPA
No.1 & Btr		1985	2280	1,800,000		
No.1		1725	1985	1,700,000		
No.2		1510	1735	1,600,000		
No.3		865	990	1,400,000		
Stud		855	980	1,400,000		
Construction		1150	1325	1,500,000		
Standard		635	725	1,400,000		
Utility		315	365	1,300,000		
Select Structural	2x6	2170	2495	1,900,000		
No.1 & Btr		1720	1975	1,800,000		
No.1		1495	1720	1,700,000		
No.2		1310	1505	1,600,000		
No.3		750	860	1,400,000		
Stud		775	895	1,400,000		
Select Structural	2x8	2000	2300	1,900,000		
No.1 & Str		1585	1825	1,800,000		
No.1	1380	1585	1,700,000			
No.2	1210	1390	1,600,000			
No.3	690	795	1,400,000			
Select Structural	2x10	1835	2110	1,900,000		
No.1 & Btr		1455	1675	1,800,000		
No.1		1265	1455	1,700,000		
No.2		1105	1275	1,600,000		
No.3		635	725	1,400,000		
Select Structural		2x12	1670	1920	1,900,000	
No.1 & Btr	1325		1520	1,800,000		
No.1	1150		1325	1,700,000		
No.2	1005		1155	1,600,000		
No.3	575		660	1,400,000		

Page intentionally left blank.

**TABLE F- 2  
FLOOR JOISTS WITH L/360 DEFLECTION LIMITS**

**DESIGN CRITERIA:**

Deflection – For 40 psf live load.  
Limited to span in inches divided by 360.  
Strength – Live load of 40 psf plus dead load  
of 10 psf determines the required bending design value.

Joist Size (in)	Spacing (in)	Modulus of Elasticity, E, in 1,000,000 psi																	
		0.8	0.9	1.0	1.1	1.2	1.3	1.4	1.5	1.6	1.7	1.8	1.9	2.0	2.1	2.2	2.3	2.4	
2x 6	12.0	8- 6	8-10	9- 2	9- 6	9- 9	10- 0	10- 3	10- 6	10- 9	10-11	11- 2	11- 4	11- 7	11- 9	11-11	12- 1	12- 3	
	16.0	7- 9	8- 0	8- 4	8- 7	8-10	9- 1	9- 4	9- 6	9- 9	9-11	10- 2	10- 4	10- 6	10- 8	10-10	11- 0	11- 2	
	19.2	7- 3	7- 7	7-10	8- 1	8- 4	8- 7	8- 9	9- 0	9- 2	9- 4	9- 6	9- 8	9-10	10- 0	10- 2	10- 4	10- 6	
	24.0	6- 9	7- 0	7- 3	7- 6	7- 9	7-11	8- 2	8- 4	8- 6	8- 8	8-10	9- 0	9- 2	9- 4	9- 6	9- 7	9- 9	
2x 8	12.0	11- 3	11- 8	12- 1	12- 6	12-10	13- 2	13- 6	13-10	14- 2	14- 5	14- 8	15- 0	15- 3	15- 6	15- 9	15-11	16- 2	
	16.0	10- 2	10- 7	11- 0	11- 4	11- 8	12- 0	12- 3	12- 7	12-10	13- 1	13- 4	13- 7	13-10	14- 1	14- 3	14- 6	14- 8	
	19.2	9- 7	10- 0	10- 4	10- 8	11- 0	11- 3	11- 7	11-10	12- 1	12- 4	12- 7	12-10	13- 0	13- 3	13- 5	13- 8	13-10	
	24.0	8-11	9- 3	9- 7	9-11	10- 2	10- 6	10- 9	11- 0	11- 3	11- 5	11- 8	11-11	12- 1	12- 3	12- 6	12- 8	12-10	
2x10	12.0	14- 4	14-11	15- 5	15-11	16- 5	16-10	17- 3	17- 8	18- 0	18- 5	18- 9	19- 1	19- 5	19- 9	20- 1	20- 4	20- 8	
	16.0	13- 0	13- 6	14- 0	14- 6	14-11	15- 3	15- 8	16- 0	16- 5	16- 9	17- 0	17- 4	17- 8	17-11	18- 3	18- 6	18- 9	
	19.2	12- 3	12- 9	13- 2	13- 7	14- 0	14- 5	14- 9	15- 1	15- 5	15- 9	16- 0	16- 4	16- 7	16-11	17- 2	17- 5	17- 8	
	24.0	11- 4	11-10	12- 3	12- 8	13- 0	13- 4	13- 8	14- 0	14- 4	14- 7	14-11	15- 2	15- 5	15- 8	15-11	16- 2	16- 5	
2x12	12.0	17- 5	18- 1	18- 9	19- 4	19-11	20- 6	21- 0	21- 6	21-11	22- 5	22-10	23- 3	23- 7	24- 0	24- 5	24- 9	25- 1	
	16.0	15-10	16- 5	17- 0	17- 7	18- 1	18- 7	19- 1	19- 6	19-11	20- 4	20- 9	21- 1	21- 6	21-10	22- 2	22- 6	22-10	
	19.2	14-11	15- 6	16- 0	16- 7	17- 0	17- 6	17-11	18- 4	18- 9	19- 2	19- 6	19-10	20- 2	20- 6	20-10	21- 2	21- 6	
	24.0	13-10	14- 4	14-11	15- 4	15-10	16- 3	16- 8	17- 0	17- 5	17- 9	18- 1	18- 5	18- 9	19- 1	19- 4	19- 8	19-11	
F <sub>b</sub>	12.0	718	777	833	888	941	993	1043	1092	1140	1187	1233	1278	1323	1367	1410	1452	1494	
F <sub>b</sub>	16.0	790	855	917	977	1036	1093	1148	1202	1255	1306	1357	1407	1456	1504	1551	1598	1644	
F <sub>b</sub>	19.2	840	909	975	1039	1101	1161	1220	1277	1333	1388	1442	1495	1547	1598	1649	1698	1747	
F <sub>b</sub>	24.0	905	979	1050	1119	1186	1251	1314	1376	1436	1496	1554	1611	1667	1722	1776	1829	1882	

southern pine

**Note:** The required bending design value, F<sub>b</sub>, in pounds per square inch is shown at the bottom of each table and is applicable to all lumber sizes shown. Spans are shown in feet-inches and are limited to 26' and less. Check sources of supply for availability of lumber in lengths greater than 20'.

**TABLE C-1  
CEILING JOISTS WITH L/240 DEFLECTION LIMITS**

**DESIGN CRITERIA:**

Deflection – For 10 psf live load.  
 Limited to span in inches divided by 240.  
 Strength – Live Load of 10 psf plus  
 dead load of 5 psf determines the required fiber stress value.

Joist Size (in)	Spacing (in)	Modulus of Elasticity, E, in 1,000,000 psi																
		0.8	0.9	1.0	1.1	1.2	1.3	1.4	1.5	1.6	1.7	1.8	1.9	2.0	2.1	2.2	2.3	2.4
2x 4	12.0	9-10	10-3	10-7	10-11	11-3	11-7	11-10	12-2	12-5	12-8	12-11	13-2	13-4	13-7	13-9	14-0	14-2
	16.0	8-11	9-4	9-8	9-11	10-3	10-6	10-9	11-0	11-3	11-6	11-9	11-11	12-2	12-4	12-6	12-9	12-11
	19.2	8-5	8-9	9-1	9-4	9-8	9-11	10-2	10-4	10-7	10-10	11-0	11-3	11-5	11-7	11-9	12-0	12-2
	24.0	7-10	8-1	8-5	8-8	8-11	9-2	9-5	9-8	9-10	10-0	10-3	10-5	10-7	10-9	10-11	11-1	11-3
2x 6	12.0	15-6	16-1	16-8	17-2	17-8	18-2	18-8	19-1	19-6	19-11	20-3	20-8	21-0	21-4	21-8	22-0	22-4
	16.0	14-1	14-7	15-2	15-7	16-1	16-6	16-11	17-4	17-8	18-1	18-5	18-9	19-1	19-5	19-8	20-0	20-3
	19.2	13-3	13-9	14-3	14-8	15-2	15-7	15-11	16-4	16-8	17-0	17-4	17-8	17-11	18-3	18-6	18-10	19-1
	24.0	12-3	12-9	13-3	13-8	14-1	14-5	14-9	15-2	15-6	15-9	16-1	16-4	16-8	16-11	17-2	17-5	17-8
2x 8	12.0	20-5	21-2	21-11	22-8	23-4	24-0	24-7	25-2	25-8								
	16.0	18-6	19-3	19-11	20-7	21-2	21-9	22-4	22-10	23-4	23-10	24-3	24-8	25-2	25-7	25-11		
	19.2	17-5	18-1	18-9	19-5	19-11	20-6	21-0	21-6	21-11	22-5	22-10	23-3	23-8	24-0	24-5	24-9	25-2
	24.0	16-2	16-10	17-5	18-0	18-6	19-0	19-6	19-11	20-5	20-10	21-2	21-7	21-11	22-4	22-8	23-0	23-4
2x10	12.0	26-0																
	16.0	23-8	24-7	25-5														
	19.2	22-3	23-1	23-11	24-9	25-5												
	24.0	20-8	21-6	22-3	22-11	23-8	24-3	24-10	25-5	26-0								
F <sub>b</sub>	12.0	711	769	825	880	932	983	1033	1082	1129	1176	1221	1266	1310	1354	1396	1438	1480
F <sub>b</sub>	16.0	783	847	909	968	1026	1082	1137	1191	1243	1294	1344	1394	1442	1490	1537	1583	1629
F <sub>b</sub>	19.2	832	900	965	1029	1090	1150	1208	1265	1321	1375	1429	1481	1533	1583	1633	1682	1731
F <sub>b</sub>	24.0	896	969	1040	1108	1174	1239	1302	1363	1423	1481	1539	1595	1651	1706	1759	1812	1864

**Note:** The required bending design value, F<sub>b</sub>, in pounds per square inch is shown at the bottom of each table and is applicable to all lumber sizes shown. Spans are shown in feet-inches and are limited to 26' and less. Check sources of supply for availability of lumber in lengths greater than 20'.

**TABLE C-2  
CEILING JOISTS WITH L/240 DEFLECTION LIMITS**

**DESIGN CRITERIA:**

Deflection – For 20 psf live load.

Limited to span in inches divided by 240.

Strength – Live Load of 20 psf plus

dead load of 10 psf determines the required bending design value.

Size (in)	Spacing (in)	Joist Modulus of Elasticity, E, in 1,000,000 psi																
		0.8	0.9	1.0	1.1	1.2	1.3	1.4	1.5	1.6	1.7	1.8	1.9	2.0	2.1	2.2	2.3	2.4
2x 4	12.0	7-10	8- 1	8- 5	8- 8	8-11	9- 2	9- 5	9- 8	9-10	10- 0	10- 3	10- 5	10- 7	10- 9	10-11	11- 1	11- 3
	16.0	7- 1	7- 5	7- 8	7-11	8- 1	8- 4	8- 7	8- 9	8-11	9- 1	9- 4	9- 6	9- 8	9- 9	9-11	10- 1	10- 3
	19.2	6- 8	6-11	7- 2	7- 5	7- 8	7-10	8- 1	8- 3	8- 5	8- 7	8- 9	8-11	9- 1	9- 3	9- 4	9- 6	9- 8
	24.0	6- 2	6- 5	6- 8	6-11	7- 1	7- 3	7- 6	7- 8	7-10	8- 0	8- 1	8- 3	8- 5	8- 7	8- 8	8-10	8-11
2x 6	12.0	12- 3	12- 9	13- 3	13- 8	14- 1	14- 5	14- 9	15- 2	15- 6	15- 9	16- 1	16- 4	16- 8	16-11	17- 2	17- 5	17- 8
	16.0	11- 2	11- 7	12- 0	12- 5	12- 9	13- 1	13- 5	13- 9	14- 1	14- 4	14- 7	14-11	15- 2	15- 5	15- 7	15-10	16- 1
	19.2	10- 6	10-11	11- 4	11- 8	12- 0	12- 4	12- 8	12-11	13- 3	13- 6	13- 9	14- 0	14- 3	14- 6	14- 8	14-11	15- 2
	24.0	9- 9	10- 2	10- 6	10-10	11- 2	11- 5	11- 9	12- 0	12- 3	12- 6	12- 9	13- 0	13- 3	13- 5	13- 8	13-10	14- 1
2x 8	12.0	16- 2	16-10	17- 5	18- 0	18- 6	19- 0	19- 6	19-11	20- 5	20-10	21- 2	21- 7	21-11	22- 4	22- 8	23- 0	23- 4
	16.0	14- 8	15- 3	15-10	16- 4	16-10	17- 3	17- 9	18- 1	18- 6	18-11	19- 3	19- 7	19-11	20- 3	20- 7	20-11	21- 2
	19.2	13-10	14- 5	14-11	15- 5	15-10	16- 3	16- 8	17- 1	17- 5	17- 9	18- 1	18- 5	18- 9	19- 1	19- 5	19- 8	19-11
	24.0	12-10	13- 4	13-10	14- 3	14- 8	15- 1	15- 6	15-10	16- 2	16- 6	16-10	17- 2	17- 5	17- 9	18- 0	18- 3	18- 6
2x10	12.0	20- 8	21- 6	22- 3	22-11	23- 8	24- 3	24-10	25- 5	26- 0								
	16.0	18- 9	19- 6	20- 2	20-10	21- 6	22- 1	22- 7	23- 1	23- 8	24- 1	24- 7	25- 0	25- 5	25-10			
	19.2	17- 8	18- 4	19- 0	19- 7	20- 2	20- 9	21- 3	21- 9	22- 3	22- 8	23- 1	23- 7	23-11	24- 4	24- 9	25- 1	25- 5
	24.0	16- 5	17- 0	17- 8	18- 3	18- 9	19- 3	19- 9	20- 2	20- 8	21- 1	21- 6	21-10	22- 3	22- 7	22-11	23- 4	23- 8
F <sub>b</sub>	12.0	896	969	1040	1108	1174	1239	1302	1363	1423	1481	1539	1595	1651	1706	1759	1812	1864
F <sub>b</sub>	16.0	986	1067	1145	1220	1293	1364	1433	1500	1566	1631	1694	1756	1817	1877	1936	1995	2052
F <sub>b</sub>	19.2	1048	1134	1216	1296	1374	1449	1522	1594	1664	1733	1800	1866	1931	1995	2058	2120	2181
F <sub>b</sub>	24.0	1129	1221	1310	1396	1480	1561	1640	1717	1793	1866	1939	2010	2080	2149	2217	2283	2349

**Note:** The required bending design value, F<sub>b</sub>, in pounds per square inch is shown at the bottom of each table and is applicable to all lumber sizes shown. Spans are shown in feet-inches and are limited to 26' and less. Check sources of supply for availability of lumber in lengths greater than 20'.

**TABLE R-2  
RAFTERS WITH L/240 DEFLECTION LIMITATION**

**DESIGN CRITERIA:**

Strength – Live Load of 30 psf plus  
 Dead Load of 10 psf determines the required bending design value.  
 Deflection – For 30 psf live load.  
 Limited to span in inches divided by 240.

Size (in)	Spacing (in)	Rafter Bending Design Value, $F_b$ (psi)																					
		300	400	500	600	700	800	900	1000	1100	1200	1300	1400	1500	1600	1700	1800	1900	2000	2100	2200	2300	2400
2x 6	12.0	6-2	7-1	7-11	8-8	9-5	10-0	10-8	11-3	11-9	12-4	12-10	13-3	13-9	14-2	14-8	15-1	15-6	15-11				
	16.0	5-4	6-2	6-10	7-6	8-2	8-8	9-3	9-9	10-2	10-8	11-1	11-6	11-11	12-4	12-8	13-1	13-5	13-9	14-1	14-5		
	19.2	4-10	5-7	6-3	6-10	7-5	7-11	8-5	8-11	9-4	9-9	10-1	10-6	10-10	11-3	11-7	11-11	12-3	12-7	12-10	13-2	13-6	
	24.0	4-4	5-0	5-7	6-2	6-8	7-1	7-6	7-11	8-4	8-8	9-1	9-5	9-9	10-0	10-4	10-8	10-11	11-3	11-6	11-9	12-0	12-4
2x 8	12.0	8-1	9-4	10-6	11-6	12-5	13-3	14-0	14-10	15-6	16-3	16-10	17-6	18-1	18-9	19-4	19-10	20-5	20-11				
	16.0	7-0	8-1	9-1	9-11	10-9	11-6	12-2	12-10	13-5	14-0	14-7	15-2	15-8	16-3	16-9	17-2	17-8	18-1	18-7	19-0		
	19.2	6-5	7-5	8-3	9-1	9-9	10-6	11-1	11-8	12-3	12-10	13-4	13-10	14-4	14-10	15-3	15-8	16-2	16-7	16-11	17-4	17-9	
	24.0	5-9	6-7	7-5	8-1	8-9	9-4	9-11	10-6	11-0	11-6	11-11	12-5	12-10	13-3	13-8	14-0	14-5	14-10	15-2	15-6	15-10	16-3
2x10	12.0	10-4	11-11	13-4	14-8	15-10	16-11	17-11	18-11	19-10	20-8	21-6	22-4	23-1	23-11	24-7	25-4	26-0					
	16.0	8-11	10-4	11-7	12-8	13-8	14-8	15-6	16-4	17-2	17-11	18-8	19-4	20-0	20-8	21-4	21-11	22-6	23-1	23-8	24-3		
	19.2	8-2	9-5	10-7	11-7	12-6	13-4	14-2	14-11	15-8	16-4	17-0	17-8	18-3	18-11	19-6	20-0	20-7	21-1	21-8	22-2	22-8	
	24.0	7-4	8-5	9-5	10-4	11-2	11-11	12-8	13-4	14-0	14-8	15-3	15-10	16-4	16-11	17-5	17-11	18-5	18-11	19-4	19-10	20-3	20-8
2x12	12.0	12-7	14-6	16-3	17-9	19-3	20-6	21-9	23-0	24-1	25-2												
	16.0	10-11	12-7	14-1	15-5	16-8	17-9	18-10	19-11	20-10	21-9	22-8	23-6	24-4	25-2	25-11							
	19.2	9-11	11-6	12-10	14-1	15-2	16-3	17-3	18-2	19-0	19-11	20-8	21-6	22-3	23-0	23-8	24-4	25-0	25-8				
	24.0	8-11	10-3	11-6	12-7	13-7	14-6	15-5	16-3	17-0	17-9	18-6	19-3	19-11	20-6	21-2	21-9	22-5	23-0	23-6	24-1	24-8	25-2
E	12.0	0.15	0.23	0.32	0.43	0.54	0.66	0.78	0.92	1.06	1.21	1.36	1.52	1.69	1.86	2.04	2.22	2.41	2.60				
E	16.0	0.13	0.20	0.28	0.37	0.47	0.57	0.68	0.80	0.92	1.05	1.18	1.32	1.46	1.61	1.76	1.92	2.08	2.25	2.42	2.60		
E	19.2	0.12	0.18	0.26	0.34	0.43	0.52	0.62	0.73	0.84	0.95	1.08	1.20	1.33	1.47	1.61	1.75	1.90	2.05	2.21	2.37	2.53	
E	24.0	0.11	0.16	0.23	0.30	0.38	0.46	0.55	0.65	0.75	0.85	0.96	1.08	1.19	1.31	1.44	1.57	1.70	1.84	1.98	2.12	2.27	2.41

**Note:** The required modulus of elasticity, E, in 1,000,000 pounds per square inch is shown at the bottom of each table, is limited to 2.6 million psi and less, and is applicable to all lumber sizes shown. Spans are shown in feet-inches and are limited to 26' and less. Check sources of supply for availability of lumber in lengths greater than 20'.

**TABLE R-3  
RAFTERS WITH L/240 DEFLECTION LIMITATION**

**DESIGN CRITERIA:**

Strength – Live Load of 40 psf plus

Dead Load of 10 psf determines the required bending design value.

Deflection – For 40 psf live load.

Limited to span in inches divided by 240.

Size (in)	Spacing (in)	Rafter Bending Design Value, $F_b$ (psi)																					
		300	400	500	600	700	800	900	1000	1100	1200	1300	1400	1500	1600	1700	1800	1900	2000	2100	2200	2300	2400
2x 6	12.0	5-6	6-4	7-1	7-9	8-5	9-0	9-6	10-0	10-6	11-0	11-5	11-11	12-4	12-8	13-1	13-6	13-10	14-2				
	16.0	4-9	5-6	6-2	6-9	7-3	7-9	8-3	8-8	9-1	9-6	9-11	10-3	10-8	11-0	11-4	11-8	12-0	12-4	12-7	12-11		
	19.2	4-4	5-0	5-7	6-2	6-8	7-1	7-6	7-11	8-4	8-8	9-1	9-5	9-9	10-0	10-4	10-8	10-11	11-3	11-6	11-9	12-0	12-4
	24.0	3-11	4-6	5-0	5-6	5-11	6-4	6-9	7-1	7-5	7-9	8-1	8-5	8-8	9-0	9-3	9-6	9-9	10-0	10-3	10-6	10-9	11-0
2x 8	12.0	7-3	8-4	9-4	10-3	11-1	11-10	12-7	13-3	13-11	14-6	15-1	15-8	16-3	16-9	17-3	17-9	18-3	18-9				
	16.0	6-3	7-3	8-1	8-11	9-7	10-3	10-10	11-6	12-0	12-7	13-1	13-7	14-0	14-6	14-11	15-5	15-10	16-3	16-7	17-0		
	19.2	5-9	6-7	7-5	8-1	8-9	9-4	9-11	10-6	11-0	11-6	11-11	12-5	12-10	13-3	13-8	14-0	14-5	14-10	15-2	15-6	15-10	16-3
	24.0	5-2	5-11	6-7	7-3	7-10	8-4	8-11	9-4	9-10	10-3	10-8	11-1	11-6	11-10	12-2	12-7	12-11	13-3	13-7	13-11	14-2	14-6
2x10	12.0	9-3	10-8	11-11	13-1	14-2	15-1	16-0	16-11	17-9	18-6	19-3	20-0	20-8	21-4	22-0	22-8	23-3	23-11				
	16.0	8-0	9-3	10-4	11-4	12-3	13-1	13-10	14-8	15-4	16-0	16-8	17-4	17-11	18-6	19-1	19-7	20-2	20-8	21-2	21-8		
	19.2	7-4	8-5	9-5	10-4	11-2	11-11	12-8	13-4	14-0	14-8	15-3	15-10	16-4	16-11	17-5	17-11	18-5	18-11	19-4	19-10	20-3	20-8
	24.0	6-6	7-7	8-5	9-3	10-0	10-8	11-4	11-11	12-6	13-1	13-7	14-2	14-8	15-1	15-7	16-0	16-6	16-11	17-4	17-9	18-1	18-6
2x12	12.0	11-3	13-0	14-6	15-11	17-2	18-4	19-6	20-6	21-7	22-6	23-5	24-4	25-2	26-0								
	16.0	9-9	11-3	12-7	13-9	14-11	15-11	16-10	17-9	18-8	19-6	20-3	21-1	21-9	22-6	23-2	23-10	24-6	25-2	25-9			
	19.2	8-11	10-3	11-6	12-7	13-7	14-6	15-5	16-3	17-0	17-9	18-6	19-3	19-11	20-6	21-2	21-9	22-5	23-0	23-6	24-1	24-8	25-2
	24.0	7-11	9-2	10-3	11-3	12-2	13-0	13-9	14-6	15-3	15-11	16-7	17-2	17-9	18-4	18-11	19-6	20-0	20-6	21-1	21-7	22-0	22-6
E	12.0	0.14	0.22	0.31	0.41	0.51	0.63	0.75	0.88	1.01	1.15	1.30	1.45	1.61	1.77	1.94	2.12	2.30	2.48				
E	16.0	0.12	0.19	0.27	0.35	0.44	0.54	0.65	0.76	0.88	1.00	1.12	1.26	1.39	1.54	1.68	1.83	1.99	2.15	2.31	2.48		
E	19.2	0.11	0.18	0.24	0.32	0.41	0.50	0.59	0.69	0.80	0.91	1.03	1.15	1.27	1.40	1.54	1.67	1.81	1.96	2.11	2.26	2.42	2.58
E	24.0	0.10	0.16	0.22	0.29	0.36	0.44	0.53	0.62	0.71	0.81	0.92	1.03	1.14	1.25	1.37	1.50	1.62	1.75	1.89	2.02	2.16	2.30

**Note:** The required modulus of elasticity, E, in 1,000,000 pounds per square inch is shown at the bottom of each table, is limited to 2.6 million psi and less, and is applicable to all lumber sizes shown. Spans are shown in feet-inches and are limited to 26' and less. Check sources of supply for availability of lumber in lengths greater than 20'.

**TABLE R-10  
RAFTERS WITH L/240 DEFLECTION LIMITATION**

**DESIGN CRITERIA**

Strength – Live Load of 30 psf plus  
 Dead Load of 20 psf determines the required bending design value  
 Deflection – For 30 psf live load.  
 Limited to span in inches divided by 240.

Size (in)	Spacing (in)	Rafter Bending Design Value, $F_b$ , (psi)																									
		300	400	500	600	700	800	900	1000	1100	1200	1300	1400	1500	1600	1700	1800	1900	2000	2100	2200	2300	2400	2500	2600	2700	
2x 6	12.0	5-6	6-4	7-1	7-9	8-5	9-0	9-6	10-0	10-6	11-0	11-5	11-11	12-4	12-8	13-1	13-6	13-10	14-2	14-7	14-11	15-3	15-7	15-11			
	16.0	4-9	5-6	6-2	6-9	7-3	7-9	8-3	8-8	9-1	9-6	9-11	10-3	10-8	11-0	11-4	11-8	12-0	12-4	12-7	12-11	13-2	13-6	13-9	14-0	14-3	
	19.2	4-4	5-0	5-7	6-2	6-8	7-1	7-6	7-11	8-4	8-8	9-1	9-5	9-9	10-0	10-4	10-8	10-11	11-3	11-6	11-9	12-0	12-4	12-7	12-10	13-1	
	24.0	3-11	4-6	5-0	5-6	5-11	6-4	6-9	7-1	7-5	7-9	8-1	8-5	8-8	9-0	9-3	9-6	9-9	10-0	10-3	10-6	10-9	11-0	11-3	11-5	11-8	
2x 8	12.0	7-3	8-4	9-4	10-3	11-1	11-10	12-7	13-3	13-11	14-6	15-1	15-8	16-3	16-9	17-3	17-9	18-3	18-9	19-2	19-8	20-1	20-6	20-11			
	16.0	6-3	7-3	8-1	8-11	9-7	10-3	10-10	11-6	12-0	12-7	13-1	13-7	14-0	14-6	14-11	15-5	15-10	16-3	16-7	17-0	17-5	17-9	18-1	18-6	18-10	
	19.2	5-9	6-7	7-5	8-1	8-9	9-4	9-11	10-6	11-0	11-6	11-11	12-5	12-10	13-3	13-8	14-0	14-5	14-10	15-2	15-6	15-10	16-3	16-7	16-10	17-2	
	24.0	5-2	5-11	6-7	7-3	7-10	8-4	8-11	9-4	9-10	10-3	10-8	11-1	11-6	11-10	12-2	12-7	12-11	13-3	13-7	13-11	14-2	14-6	14-10	15-1	15-5	
2x10	12.0	9-3	10-8	11-11	13-1	14-2	15-1	16-0	16-11	17-9	18-6	19-3	20-0	20-8	21-4	22-0	22-8	23-3	23-11	24-6	25-1	25-7					
	16.0	8-0	9-3	10-4	11-4	12-3	13-1	13-10	14-8	15-4	16-0	16-8	17-4	17-11	18-6	19-1	19-7	20-2	20-8	21-2	21-8	22-2	22-8	23-1	23-7	24-0	
	19.2	7-4	8-5	9-5	10-4	11-2	11-11	12-8	13-4	14-0	14-8	15-3	15-10	16-4	16-11	17-5	17-11	18-5	18-11	19-4	19-10	20-3	20-8	21-1	21-6	21-11	
	24.0	6-6	7-7	8-5	9-3	10-0	10-8	11-4	11-11	12-6	13-1	13-7	14-2	14-8	15-1	15-7	16-0	16-6	16-11	17-4	17-9	18-1	18-6	18-11	19-3	19-7	
2x12	12.0	11-3	13-0	14-6	15-11	17-2	18-4	19-6	20-6	21-7	22-6	23-5	24-4	25-2	26-0												
	16.0	9-9	11-3	12-7	13-9	14-11	15-11	16-10	17-9	18-8	19-6	20-3	21-1	21-9	22-6	23-2	23-10	24-6	25-2	25-9							
	19.2	8-11	10-3	11-6	12-7	13-7	14-6	15-5	16-3	17-0	17-9	18-6	19-3	19-11	20-6	21-2	21-9	22-5	23-0	23-6	24-1	24-8	25-2	25-8			
	24.0	7-11	9-2	10-3	11-3	12-2	13-0	13-9	14-6	15-3	15-11	16-7	17-2	17-9	18-4	18-11	19-6	20-0	20-6	21-1	21-7	22-0	22-6	23-0	23-5	23-10	
E	12.0	0.11	0.17	0.23	0.31	0.38	0.47	0.56	0.66	0.76	0.86	0.97	1.09	1.21	1.33	1.46	1.59	1.72	1.86	2.00	2.14	2.29	2.44	2.60			
E	16.0	0.09	0.14	0.20	0.26	0.33	0.41	0.49	0.57	0.66	0.75	0.84	0.94	1.05	1.15	1.26	1.37	1.49	1.61	1.73	1.86	1.99	2.12	2.25	2.39	2.53	
E	19.2	0.09	0.13	0.18	0.24	0.30	0.37	0.44	0.52	0.60	0.68	0.77	0.86	0.95	1.05	1.15	1.25	1.36	1.47	1.58	1.70	1.81	1.93	2.05	2.18	2.31	
E	24.0	0.08	0.12	0.16	0.22	0.27	0.33	0.40	0.46	0.54	0.61	0.69	0.77	0.85	0.94	1.03	1.12	1.22	1.31	1.41	1.52	1.62	1.73	1.84	1.95	2.06	

**Note:** The required modulus of elasticity, E, in 1,000,000 pounds per square inch is shown at the bottom of each table, is limited to 2.6 million psi and less, and is applicable to all lumber sizes shown. Spans are shown in feet-inches and are limited to 26' and less. Check sources of supply for availability of lumber in lengths greater than 20'.

**TABLE R-11  
RAFTERS WITH L/240 DEFLECTION LIMITATION**

**DESIGN CRITERIA:**

Strength – Live Load of 40 psf plus

Dead Load of 20 psf determines the required bending design value.

Deflection – For 40 psf live load.

Limited to span in inches divided by 240.

Size (in)	Spacing (in)	Rafter Bending Design Value, F <sub>b</sub> , (psi)																								
		300	400	500	600	700	800	900	1000	1100	1200	1300	1400	1500	1600	1700	1800	1900	2000	2100	2200	2300	2400	2500	2600	2700
2x6	12.0	5-0	5-10	6-6	7-1	7-8	8-2	8-8	9-2	10-6	11-0	11-5	11-11	12-4	12-8	13-1	13-6	13-10	14-2	14-7	14-11	15-3	15-7	15-11		
	16.0	4-4	5-0	5-7	6-2	6-8	7-1	7-6	7-11	9-1	9-6	9-11	10-3	10-8	11-0	11-4	11-8	12-0	12-4	12-7	12-11	13-2	13-6	13-9	14-0	14-3
	19.2	4-0	4-7	5-1	5-7	6-1	6-6	6-10	7-3	8-4	8-8	9-1	9-5	9-9	10-0	10-4	10-8	10-11	11-3	11-6	11-9	12-0	12-4	12-7	12-10	13-1
	24.0	3-7	4-1	4-7	5-0	5-5	5-10	6-2	6-6	7-5	7-9	8-1	8-5	8-8	9-0	9-3	9-6	9-9	10-0	10-3	10-6	10-9	11-0	11-3	11-5	11-8
2x8	12.0	6-7	7-8	8-7	9-4	10-1	10-10	11-6	12-1	13-11	14-6	15-1	15-8	16-3	16-9	17-3	17-9	18-3	18-9	19-2	19-8	20-1	20-6	20-11		
	16.0	5-9	6-7	7-5	8-1	8-9	9-4	9-11	10-6	12-0	12-7	13-1	13-7	14-0	14-6	14-11	15-5	15-10	16-3	16-7	17-0	17-5	17-9	18-1	18-6	18-10
	19.2	5-3	6-0	6-9	7-5	8-0	8-7	9-1	9-7	11-0	11-6	11-11	12-5	12-10	13-3	13-8	14-0	14-5	14-10	15-2	15-6	15-10	16-3	16-7	16-10	17-2
	24.0	4-8	5-5	6-0	6-7	7-2	7-9	8-1	8-7	9-10	10-3	10-8	11-1	11-6	11-10	12-2	12-7	12-11	13-3	13-7	13-11	14-2	14-6	14-10	15-1	15-5
2x10	12.0	8-5	9-9	10-11	11-11	12-11	13-9	14-8	15-5	17-9	18-6	19-3	20-0	20-8	21-4	22-0	22-8	23-3	23-11	24-6	25-1	25-7				
	16.0	7-4	8-5	9-5	10-4	11-2	11-11	12-8	13-4	15-4	16-0	16-8	17-4	17-11	18-6	19-1	19-7	20-2	20-8	21-2	21-8	22-2	22-8	23-1	23-7	24-0
	19.2	6-8	7-8	8-7	9-5	10-2	10-11	11-7	12-2	14-0	14-8	15-3	15-10	16-4	16-11	17-5	17-11	18-5	18-11	19-4	19-10	20-3	20-8	21-1	21-6	21-11
	24.0	6-0	6-11	7-8	8-5	9-1	9-9	10-4	10-11	12-6	13-1	13-7	14-2	14-8	15-1	15-7	16-0	16-6	16-11	17-4	17-9	18-1	18-6	18-11	19-3	19-7
2x12	12.0	10-3	11-10	13-3	14-6	15-8	16-9	17-9	18-9	21-7	22-6	23-5	24-4	25-2	26-0											
	16.0	8-11	10-3	11-6	12-7	13-7	14-6	15-5	16-3	18-8	19-6	20-3	21-1	21-9	22-6	23-2	23-10	24-6	25-2	25-9						
	19.2	8-1	9-4	10-6	11-6	12-5	13-3	14-1	14-10	17-0	17-9	18-6	19-3	19-11	20-6	21-2	21-9	22-5	23-0	23-6	24-1	25-2	25-8			
	24.0	7-3	8-5	9-4	10-3	11-1	11-10	12-7	13-3	15-3	15-11	16-7	17-2	17-9	18-4	18-11	19-6	20-0	20-6	21-1	21-7	22-0	22-6	23-0	23-5	23-10
E	12.0	0.11	0.17	0.24	0.31	0.39	0.48	0.57	0.67	0.76	0.86	0.97	1.09	1.21	1.33	1.46	1.59	1.72	1.86	2.00	2.14	2.29	2.44	2.60		
E	16.0	0.09	0.15	0.20	0.27	0.34	0.41	0.49	0.58	0.66	0.75	0.84	0.94	1.05	1.15	1.26	1.37	1.49	1.61	1.73	1.86	1.99	2.12	2.25	2.39	2.53
E	19.2	0.09	0.13	0.19	0.24	0.31	0.38	0.45	0.53	0.60	0.68	0.77	0.86	0.95	1.05	1.15	1.25	1.36	1.47	1.58	1.70	1.81	1.93	2.05	2.18	2.31
E	24.0	0.08	0.12	0.17	0.22	0.28	0.34	0.40	0.47	0.54	0.61	0.69	0.77	0.85	0.94	2.03	1.12	1.22	1.31	1.41	1.52	1.62	1.73	1.84	1.95	2.06

**Note:** The required modulus of elasticity, E, in 1,000,000 pounds per square inch is shown at the bottom of each table, is limited to 2.6 million psi and less, and is applicable to all lumber sizes shown. Spans are shown in feet-inches and are limited to 26' and less. Check sources of supply for availability of lumber in lengths greater than 20'.

**TABLE R-14  
RAFTERS WITH L/180 DEFLECTION LIMITATION**

**DESIGN CRITERIA:**

Strength – Live Load of 30 psf plus  
 Dead Load of 10 psf determines the required bending design value.  
 Deflection – For 30 psf live load.  
 Limited to span in inches divided by 180.

southern pine - snow loading

Size (in)	Spacing (in)	Rafter Bending Design Value, $F_b$ , (psi)																																					
		200	300	400	500	600	700	800	900	1000	1100	1200	1300	1400	1500	1600	1700	1800	1900	2000	2100	2200	2300	2400	2500	2600	2700	2800	2900	3000									
2x4	12.0	3-2	3-11	4-6	5-1	5-6	6-0	6-5	6-9	7-2	7-6	7-10	8-2	8-5	8-9	9-0	9-4	9-7	9-10	10-1	10-4	10-7	10-10	11-1															
	16.0	2-9	3-5	3-11	4-4	4-10	5-2	5-6	5-10	6-2	6-6	6-9	7-1	7-4	7-7	7-10	8-1	8-40	8-6	8-9	9-0	9-2	9-5	9-7	9-9	10-0													
	19.2	2-6	3-1	3-7	4-0	4-4	4-9	5-1	5-4	5-8	5-11	6-2	6-5	6-8	6-11	7-2	7-4	7-7	7-9	8-0	8-2	8-5	8-7	8-9	8-11	9-1	9-3	9-5											
	24.0	2-3	2-9	3-2	3-7	3-11	4-3	4-6	4-10	5-1	5-4	5-6	5-9	6-0	6-2	6-5	6-7	6-9	7-0	7-2	7-4	7-6	7-8	7-10	8-0	8-2	8-4	8-5	8-7	8-9									
2x6	12.0	5-0	6-2	7-1	7-11	8-8	9-5	10-0	10-8	11-3	11-9	12-4	12-10	13-3	13-9	14-2	14-8	15-1	15-6	15-11	16-3	16-8	17-0	17-5															
	16.0	4-4	5-4	6-2	6-10	7-6	8-2	8-8	9-3	9-9	10-2	10-8	11-1	11-6	11-11	12-4	12-8	13-1	13-5	13-9	14-1	14-5	14-9	15-1	15-4	15-8													
	19.2	4-0	4-10	5-7	6-3	6-10	7-5	7-11	8-5	8-11	9-4	9-9	10-1	10-6	10-10	11-3	11-7	11-11	12-3	12-7	12-10	13-2	13-6	13-9	14-0	14-4	14-7	14-10											
	24.0	3-7	4-4	5-0	5-7	6-2	6-8	7-1	7-6	7-11	8-4	8-8	9-1	9-5	9-9	10-0	10-4	10-8	10-11	11-3	11-6	11-9	12-0	12-4	12-7	12-10	13-1	13-3	13-6	13-9									
2x8	12.0	6-7	8-1	9-4	10-6	11-6	12-5	13-3	14-0	14-10	15-6	16-3	16-10	17-6	18-1	18-9	19-4	19-10	20-5	20-11	21-5	21-11	22-5	22-11															
	16.0	5-9	7-0	8-1	9-1	9-11	10-9	11-6	12-2	12-10	13-5	14-0	14-7	15-2	15-8	16-3	16-9	17-2	17-8	18-1	18-7	19-0	19-5	19-10	20-3	20-8													
	19.2	5-3	6-5	7-5	8-3	9-1	9-9	10-6	11-1	11-8	12-3	12-10	13-4	13-10	14-4	14-10	15-3	15-8	16-2	16-7	16-11	17-4	17-9	18-1	18-6	18-10	19-3	19-7											
	24.0	4-8	5-9	6-7	7-5	8-1	8-9	9-4	9-11	10-6	11-0	11-6	11-11	12-5	12-10	13-3	13-8	14-0	14-5	14-10	15-2	15-6	15-10	16-3	16-7	16-10	17-2	17-6	17-10	18-1									
2x10	12.0	8-5	10-4	11-11	13-4	14-8	15-10	16-11	17-11	18-11	19-10	20-8	21-6	22-4	23-1	23-11	24-7	25-4	26-0																				
	16.0	7-4	8-11	10-4	11-7	12-8	13-8	14-8	15-6	16-4	17-2	17-11	18-8	19-4	20-0	20-8	21-4	21-11	22-6	23-1	23-8	24-3	24-10	25-4	25-10														
	19.2	6-8	8-2	9-5	10-7	11-7	12-6	13-4	14-2	14-11	15-8	16-4	17-0	17-8	18-3	18-11	19-6	20-0	20-7	21-1	21-8	22-2	22-8	23-1	23-7	24-1	24-6	25-0											
	24.0	6-0	7-4	8-5	9-5	10-4	11-2	11-11	12-8	13-4	14-0	14-8	15-3	15-10	16-4	16-11	17-5	17-11	18-5	18-11	19-4	19-10	20-3	20-8	21-1	21-6	21-11	22-4	22-9	23-1									
E	12.0	0.06	0.11	0.17	0.24	0.32	0.40	0.49	0.59	0.69	0.79	0.91	1.02	1.14	1.27	1.39	1.53	1.66	1.80	1.95	2.10	2.25	2.40	2.56															
E	16.0	0.05	0.10	0.15	0.21	0.28	0.35	0.43	0.51	0.60	0.69	0.78	0.88	0.99	1.10	1.21	1.32	1.44	1.56	1.69	1.82	1.95	2.08	2.22	2.36	2.50													
E	19.2	0.05	0.09	0.14	0.19	0.25	0.32	0.39	0.47	0.54	0.63	0.72	0.81	0.90	1.00	1.10	1.21	1.32	1.43	1.54	1.66	1.78	1.90	2.03	2.15	2.28	2.42	2.55											
E	24.0	0.04	0.08	0.12	0.17	0.23	0.29	0.35	0.42	0.49	0.56	0.64	0.72	0.81	0.89	0.99	1.08	1.18	1.28	1.38	1.48	1.59	1.70	1.81	1.93	2.04	2.16	2.28	2.41	2.53									

**Note:** The required modulus of elasticity, E, in 1,000,000 pounds per square inch is shown at the bottom of each table, is limited to 2.6 million psi and less, and is applicable to all lumber sizes shown. Spans are shown in feet-inches and are limited to 26' and less. Check sources of supply for availability of lumber in lengths greater than 20'.

**TABLE R-15**  
**RAFTERS WITH L/180 DEFLECTION LIMITATION**

**DESIGN CRITERIA:**

Strength – Live Load of 40 psf plus

Dead Load of 10 psf determines the required bending design value.

Deflection – For 40 psf live load.

Limited to span in inches divided by 180.

Size (in)	Spacing (in)	Rafter Bending Design Value, $F_b$ , (psi)																																		
		200	300	400	500	600	700	800	900	1000	1100	1200	1300	1400	1500	1600	1700	1800	1900	2000	2100	2200	2300	2400	2500	2600	2700	2800	2900	3000						
2x4	12.0	2-10	3-6	4-0	4-6	4-11	5-4	5-9	6-1	6-5	6-8	7-0	7-3	7-7	7-10	8-1	8-4	8-7	8-10	9-1	9-3	9-6	9-8	9-11	10-1											
	16.0	2-6	3-0	3-6	3-11	4-3	4-8	4-11	5-3	5-6	5-10	6-1	6-4	6-7	6-9	7-0	7-3	7-5	7-8	7-10	8-0	8-2	8-5	8-7	8-9	8-11	9-1									
	19.2	2-3	2-9	3-2	3-7	3-11	4-3	4-6	4-10	5-1	5-4	5-6	5-9	6-0	6-2	6-5	6-7	6-9	7-0	7-2	7-4	7-6	7-8	7-10	8-0	8-2	8-4	8-5	8-7							
	24.0	2-0	2-6	2-10	3-2	3-6	3-9	4-0	4-3	4-6	4-9	4-11	5-2	5-4	5-6	5-9	5-11	6-1	6-3	6-5	6-7	6-8	6-10	7-0	7-2	7-3	7-5	7-7	7-8	7-10						
2x6	12.0	4-6	5-6	6-4	7-1	7-9	8-5	9-0	9-6	10-0	10-6	11-0	11-5	11-11	12-4	12-8	13-1	13-6	13-10	14-2	14-7	14-11	15-3	15-7	15-11											
	16.0	3-11	4-9	5-6	6-2	6-9	7-3	7-9	8-3	8-8	9-1	9-6	9-11	10-3	10-8	11-0	11-4	11-8	12-0	12-4	12-7	12-11	13-2	13-6	13-9	14-0	14-3									
	19.2	3-7	4-4	5-0	5-7	6-2	6-8	7-1	7-6	7-11	8-4	8-8	9-1	9-5	9-9	10-0	10-4	10-8	10-11	11-3	11-6	11-9	12-0	12-4	12-7	12-10	13-1	13-3	13-6							
	24.0	3-2	3-11	4-6	5-0	5-6	5-11	6-4	6-9	7-1	7-5	7-9	8-1	8-5	8-8	9-0	9-3	9-6	9-9	10-0	10-3	10-6	10-9	11-0	11-3	11-5	11-8	11-11	12-1	12-4						
2x8	12.0	5-11	7-3	8-4	9-4	10-3	11-1	11-10	12-7	13-3	13-11	14-6	15-1	15-8	16-3	16-9	17-3	17-9	18-3	18-9	19-2	19-8	20-1	20-6	20-11											
	16.0	5-2	6-3	7-3	8-1	8-11	9-7	10-3	10-10	11-6	12-0	12-7	13-1	13-7	14-0	14-6	14-11	15-5	15-10	16-3	16-7	17-0	17-5	17-9	18-1	18-6	18-10									
	19.2	4-8	5-9	6-7	7-5	8-1	8-9	9-4	9-11	10-6	11-0	11-6	11-11	12-5	12-10	13-3	13-8	14-0	14-5	14-10	15-2	15-6	15-10	16-3	16-7	16-10	17-2	17-6	17-10							
	24.0	4-2	5-2	5-11	6-7	7-3	7-10	8-4	8-11	9-4	9-10	10-3	10-8	11-1	11-6	11-10	12-2	12-7	12-11	13-3	13-7	13-11	14-2	14-6	14-10	15-1	15-5	15-8	15-11	16-3						
2x10	12.0	7-7	9-3	10-8	11-11	13-1	14-2	15-1	16-0	16-11	17-9	18-6	19-3	20-0	20-8	21-4	22-0	22-8	23-3	23-11	24-6	25-1	25-7													
	16.0	6-6	8-0	9-3	10-4	11-4	12-3	13-1	13-10	14-8	15-4	16-0	16-8	17-4	17-11	18-6	19-1	19-7	20-2	20-8	21-2	21-8	22-2	22-8	23-1	23-7	24-0									
	19.2	6-0	7-4	8-5	9-5	10-4	11-2	11-11	12-8	13-4	14-0	14-8	15-3	15-10	16-4	16-11	17-5	17-11	18-5	18-11	19-4	19-10	20-3	20-8	21-1	21-6	21-11	22-4	22-9							
	24.0	5-4	6-6	7-7	8-5	9-3	10-0	10-8	11-4	11-11	12-6	13-1	13-7	14-2	14-8	15-1	15-7	16-0	16-6	16-11	17-4	17-9	18-1	18-6	18-11	19-3	19-7	20-0	20-4	20-8						
E	12.0	0.06	0.11	0.17	0.23	0.31	0.38	0.47	0.56	0.66	0.76	0.86	0.97	1.09	1.21	1.33	1.46	1.59	1.72	1.86	2.00	2.14	2.29	2.44	2.60											
E	16.0	0.05	0.09	0.14	0.20	0.26	0.33	0.41	0.49	0.57	0.66	0.75	0.84	0.94	1.05	1.15	1.26	1.37	1.49	1.61	1.73	1.86	1.99	2.12	2.25	2.39	2.53									
E	19.2	0.05	0.09	0.13	0.18	0.24	0.30	0.37	0.44	0.52	0.60	0.68	0.77	0.86	0.95	1.05	1.15	1.25	1.36	1.47	1.58	1.70	1.81	1.93	2.05	2.18	2.31	2.43	2.57							
E	24.0	0.04	0.08	0.12	0.16	0.22	0.27	0.33	0.40	0.46	0.54	0.61	0.69	0.77	0.85	0.94	1.03	1.12	1.22	1.31	1.41	1.52	1.62	1.73	1.84	1.95	2.06	2.18	2.30	2.41						

**Note:** The required modulus of elasticity, E, in 1,000,000 pounds per square inch is shown at the bottom of each table, is limited to 2.6 million psi and less, and is applicable to all lumber sizes shown. Spans are shown in feet-inches and are limited to 26' and less. Check sources of supply for availability of lumber in lengths greater than 20'.

**TABLE R-22  
RAFTERS WITH L/180 DEFLECTION LIMITATION**

**DESIGN CRITERIA:**

Strength – Live Load of 30 psf plus

Dead Load of 20 psf determines the required bending design value.

Deflection – For 30 psf live load.

Limited to span in inches divided by 180.

Size (in)	Spacing (in)	Rafter Bending Design Value, $F_b$ , (psi)																												
		200	300	400	500	600	700	800	900	1000	1100	1200	1300	1400	1500	1600	1700	1800	1900	2000	2100	2200	2300	2400	2500	2600	2700	2800	2900	3000
2x4	12.0	2-10	3-6	4-0	4-6	4-11	5-4	5-9	6-1	6-5	6-8	7-0	7-3	7-7	7-10	8-1	8-4	8-7	8-10	9-0	9-3	9-6	9-8	9-11	10-1	10-4	10-6	10-8	10-11	11-1
	16.0	2-6	3-0	3-6	3-11	4-3	4-8	4-11	5-3	5-6	5-10	6-1	6-4	6-7	6-9	7-0	7-3	7-5	7-8	7-10	8-0	8-2	8-5	8-7	8-9	8-11	9-1	9-3	9-5	9-7
	19.2	2-3	2-9	3-2	3-7	3-11	4-3	4-6	4-10	5-1	5-4	5-6	5-9	6-0	6-2	6-5	6-7	6-9	7-0	7-2	7-4	7-6	7-8	7-10	8-0	8-2	8-4	8-5	8-7	8-9
	24.0	2-0	2-6	2-10	3-2	3-6	3-9	4-0	4-3	4-6	4-9	4-11	5-2	5-4	5-6	5-9	5-11	6-1	6-3	6-5	6-7	6-8	6-10	7-0	7-2	7-3	7-5	7-7	7-8	7-10
2x6	12.0	4-6	5-6	6-4	7-1	7-9	8-5	9-0	9-6	10-0	10-6	11-0	11-5	11-11	12-4	12-8	13-1	13-6	13-10	14-2	14-7	14-11	15-3	15-7	15-11	16-2	16-6	16-10	17-1	17-5
	16.0	3-11	4-9	5-6	6-2	6-9	7-3	7-9	8-3	8-8	9-1	9-6	9-11	10-3	10-8	11-0	11-4	11-8	12-0	12-4	12-7	12-11	13-2	13-6	13-9	14-0	14-3	14-7	14-10	15-1
	19.2	3-7	4-4	5-0	5-7	6-2	6-8	7-1	7-6	7-11	8-4	8-8	9-1	9-5	9-9	10-0	10-4	10-8	10-11	11-3	11-6	11-9	12-0	12-4	12-7	12-10	13-1	13-3	13-6	13-9
	24.0	3-2	3-11	4-6	5-0	5-6	5-11	6-4	6-9	7-1	7-5	7-9	8-1	8-5	8-8	9-0	9-3	9-6	9-9	10-0	10-3	10-6	10-9	11-0	11-3	11-5	11-8	11-11	12-1	12-4
2x8	12.0	5-11	7-3	8-4	9-4	10-3	11-1	11-10	12-7	13-3	13-11	14-6	15-1	15-8	16-3	16-9	17-3	17-9	18-3	18-9	19-2	19-8	20-1	20-6	20-11	21-4	21-9	22-2	22-6	22-11
	16.0	5-2	6-3	7-3	8-1	8-11	9-7	10-3	10-10	11-6	12-0	12-7	13-1	13-7	14-0	14-6	14-11	15-5	15-10	16-3	16-7	17-0	17-5	17-9	18-1	18-6	18-10	19-2	19-6	19-10
	19.2	4-8	5-9	6-7	7-5	8-1	8-9	9-4	9-11	10-6	11-0	11-6	11-11	12-5	12-10	13-3	13-8	14-0	14-5	14-10	15-2	15-6	15-10	16-3	16-7	16-10	17-2	17-6	17-10	18-1
	24.0	4-2	5-2	5-11	6-7	7-3	7-10	8-4	8-11	9-4	9-10	10-3	10-8	11-1	11-6	11-10	12-2	12-7	12-11	13-3	13-7	13-11	14-2	14-6	14-10	15-1	15-5	15-8	15-11	16-3
2x10	12.0	7-7	9-3	10-8	11-11	13-1	14-2	15-1	16-0	16-11	17-9	18-6	19-3	20-0	20-8	21-4	22-0	22-8	23-3	23-11	24-6	25-1	25-7							
	16.0	6-6	8-0	9-3	10-4	11-4	12-3	13-1	13-10	14-8	15-4	16-0	16-8	17-4	17-11	18-6	19-1	19-7	20-2	20-8	21-2	21-8	22-2	22-8	23-1	23-7	24-0	24-6	24-11	25-4
	19.2	6-0	7-4	8-5	9-5	10-4	11-2	11-11	12-8	13-4	14-0	14-8	15-3	15-10	16-4	16-11	17-5	17-11	18-5	18-11	19-4	19-10	20-3	20-8	21-1	21-6	21-11	22-4	22-9	23-1
	24.0	5-4	6-6	7-7	8-5	9-3	10-0	10-8	11-4	11-11	12-6	13-1	13-7	14-2	14-8	15-1	15-7	16-0	16-6	16-11	17-4	17-9	18-1	18-6	18-11	19-3	19-7	20-0	20-4	20-8
E	12.0	0.04	0.08	0.12	0.17	0.23	0.29	0.35	0.42	0.49	0.57	0.65	0.73	0.82	0.91	1.00	1.09	1.19	1.29	1.39	1.50	1.61	1.72	1.83	1.95	2.07	2.19	2.31	2.43	2.56
E	16.0	0.04	0.07	0.11	0.15	0.20	0.25	0.31	0.36	0.43	0.49	0.56	0.63	0.71	0.78	0.86	0.95	1.03	1.12	1.21	1.30	1.39	1.49	1.59	1.69	1.79	1.89	2.00	2.11	2.22
E	19.2	0.03	0.06	0.10	0.14	0.18	0.23	0.28	0.33	0.39	0.45	0.51	0.58	0.65	0.72	0.79	0.86	0.94	1.02	1.10	1.19	1.27	1.36	1.45	1.54	1.63	1.73	1.83	1.92	2.03
E	24.0	0.03	0.06	0.09	0.12	0.16	0.20	0.25	0.30	0.35	0.40	0.46	0.52	0.58	0.64	0.71	0.77	0.84	0.91	1.00	1.06	1.14	1.22	1.30	1.38	1.46	1.55	1.63	1.72	1.81

**Note:** The required modulus of elasticity, E, in 1,000,000 pounds per square inch is shown at the bottom of each table, is limited to 2.6 million psi and less, and is applicable to all lumber sizes shown. Spans are shown in feet-inches and are limited to 26' and less. Check sources of supply for availability of lumber in lengths greater than 20'.

**TABLE R-23**  
**RAFTERS WITH L/180 DEFLECTION LIMITATION**

**DESIGN CRITERIA:**

Strength – Live Load of 40 psf plus

Dead Load of 20 psf determines the required bending design value.

Deflection – For 40 psf live load.

Limited to span in inches divided by 180.

Size (in)	Spacing (in)	Rafter Bending Design Value, $F_b$ , (psi)																												
		200	300	400	500	600	700	800	900	1000	1100	1200	1300	1400	1500	1600	1700	1800	1900	2000	2100	2200	2300	2400	2500	2600	2700	2800	2900	3000
2x4	12.0	2-7	3-2	3-8	4-1	4-6	4-11	5-3	5-6	5-10	6-1	6-5	6-8	6-11	7-2	7-5	7-7	7-10	8-0	8-3	8-5	8-8	8-10	9-0	9-3	9-5	9-7	9-9	9-11	10-1
	16.0	2-3	2-9	3-2	3-7	3-11	4-3	4-6	4-10	5-1	5-4	5-6	5-9	6-0	6-2	6-5	6-7	6-9	7-0	7-2	7-4	7-6	7-8	7-10	8-0	8-2	8-4	8-5	8-7	8-9
	19.2	2-1	2-6	2-11	3-3	3-7	3-10	4-1	4-4	4-7	4-10	5-1	5-3	5-5	5-8	5-10	6-0	6-2	6-4	6-6	6-8	6-10	7-0	7-2	7-3	7-5	7-7	7-9	7-10	8-0
	24.0	1-10	2-3	2-7	2-11	3-2	3-5	3-8	3-11	4-1	4-4	4-6	4-8	4-11	5-1	5-3	5-5	5-6	5-8	5-10	6-0	6-1	6-3	6-5	6-6	6-8	6-9	6-11	7-0	7-2
2x6	12.0	4-1	5-0	5-10	6-6	7-1	7-8	8-2	8-8	9-2	9-7	10-0	10-5	10-10	11-3	11-7	11-11	12-4	12-8	13-0	13-3	13-7	13-11	14-2	14-6	14-9	15-1	15-4	15-7	15-11
	16.0	3-7	4-4	5-0	5-7	6-2	6-8	7-1	7-6	7-11	8-4	8-8	9-1	9-5	9-9	10-0	10-4	10-8	10-11	11-3	11-6	11-9	12-0	12-4	12-7	12-10	13-1	13-3	13-6	13-9
	19.2	3-3	4-0	4-7	5-1	5-7	6-1	6-6	6-10	7-3	7-7	7-11	8-3	8-7	8-11	9-2	9-5	9-9	10-0	10-3	10-6	10-9	11-0	11-3	11-5	11-8	11-11	12-2	12-4	12-7
	24.0	2-11	3-7	4-1	4-7	5-0	5-5	5-10	6-2	6-6	6-10	7-1	7-5	7-8	7-11	8-2	8-5	8-8	8-11	9-2	9-5	9-7	9-10	10-0	10-3	10-5	10-8	10-10	11-0	11-3
2x8	12.0	5-5	6-7	7-8	8-7	9-4	10-1	10-10	11-6	12-1	12-8	13-3	13-9	14-4	14-10	15-3	15-9	16-3	16-8	17-1	17-6	17-11	18-4	18-9	19-1	19-6	19-10	20-3	20-7	20-11
	16.0	4-8	5-9	6-7	7-5	8-1	8-9	9-4	9-11	10-6	11-0	11-6	11-11	12-5	12-10	13-3	13-8	14-0	14-5	14-10	15-2	15-6	15-10	16-3	16-7	16-10	17-2	17-6	17-10	18-1
	19.2	4-3	5-3	6-0	6-9	7-5	8-0	8-7	9-1	9-7	10-0	10-6	10-11	11-4	11-8	12-1	12-5	12-10	13-2	13-6	13-10	14-2	14-6	14-10	15-1	15-5	15-8	16-0	16-3	16-7
	24.0	3-10	4-8	5-5	6-0	6-7	7-2	7-8	8-1	8-7	9-0	9-4	9-9	10-1	10-6	10-10	11-2	11-6	11-9	12-1	12-5	12-8	12-11	13-3	13-6	13-9	14-0	14-4	14-7	14-10
2x10	12.0	6-11	8-5	9-9	10-11	11-11	12-11	13-9	14-8	15-5	16-2	16-11	17-7	18-3	18-11	19-6	20-1	20-8	21-3	21-10	22-4	22-10	23-5	23-11	24-5	24-10	25-4	25-10		
	16.0	6-0	7-4	8-5	9-5	10-4	11-2	11-11	12-8	13-4	14-0	14-8	15-3	15-10	16-4	16-11	17-5	17-11	18-5	18-11	19-4	19-10	20-3	20-8	21-1	21-6	21-11	22-4	22-9	23-1
	19.2	5-5	6-8	7-8	8-7	9-5	10-2	10-11	11-7	12-2	12-9	13-4	13-11	14-5	14-11	15-5	15-11	16-4	16-10	17-3	17-8	18-1	18-6	18-11	19-3	19-8	20-0	20-5	20-9	21-1
	24.0	4-11	6-0	6-11	7-8	8-5	9-1	9-9	10-4	10-11	11-5	11-11	12-5	12-11	13-4	13-9	14-3	14-8	15-0	15-5	15-10	16-2	16-6	16-11	17-3	17-7	17-11	18-3	18-7	18-11
E	12.0	0.04	0.08	0.13	0.18	0.23	0.29	0.36	0.43	0.50	0.58	0.66	0.74	0.83	0.92	1.01	1.11	1.21	1.31	1.41	1.52	1.63	1.74	1.86	1.98	2.10	2.22	2.34	2.47	2.60
E	16.0	0.04	0.07	0.11	0.15	0.20	0.25	0.31	0.37	0.43	0.50	0.57	0.64	0.72	0.80	0.88	0.96	1.05	1.13	1.22	1.32	1.41	1.51	1.61	1.71	1.82	1.92	2.03	2.14	2.25
E	19.2	0.04	0.06	0.10	0.14	0.18	0.23	0.28	0.34	0.40	0.46	0.52	0.59	0.65	0.73	0.80	0.88	0.95	1.04	1.12	1.20	1.29	1.38	1.47	1.56	1.66	1.75	1.85	1.95	2.05
E	24.0	0.03	0.06	0.09	0.13	0.16	0.21	0.25	0.30	0.35	0.41	0.46	0.52	0.59	0.65	0.72	0.78	0.85	0.93	1.00	1.08	1.15	1.23	1.31	1.40	1.48	1.57	1.66	1.75	1.84

**Note:** The required modulus of elasticity, E, in 1,000,000 pounds per square inch is shown at the bottom of each table, is limited to 2.6 million psi and less, and is applicable to all lumber sizes shown. Spans are shown in feet-inches and are limited to 26' and less. Check sources of supply for availability of lumber in lengths greater than 20'.



**Design Values for Joists and Rafters**

These “Fb” values are for use where repetitive members are spaced not more than 24 inches. Values for surfaced dry or surfaced green lumber apply at 19% maximum moisture content in use.

Species and Grade	Size	Design Value in Bending, “Fb”		Modulus of Elasticity “E”	Grading Rules Agency	
		Normal Duration	Snow Loading			
<b>Cottonwood</b>						
Select Structural	2x4	1510	1735	1,200,000	NSLB	
No.1		1080	1240	1,200,000		
No.2		1080	1240	1,100,000		
No.3		605	695	1,000,000		
Stud		600	690	1,000,000		
Construction		805	925	1,000,000		
Standard		460	530	900,000		
Utility		200	230	900,000		
Select Structural		2x6	1310	1505		1,200,000
No.1			935	1075		1,200,000
No.2	935		1075	1,100,000		
No.3	525		600	1,000,000		
Stud	545		630	1,000,000		
Select Structural	2x8	1210	1390	1,200,000		
No.1		865	990	1,200,000		
No.2		865	990	1,100,000		
No.3		485	555	1,000,000		
Select Structural	2x10	1105	1275	1,200,000		
No.1		790	910	1,200,000		
No.2		790	910	1,100,000		
No.3		445	510	1,000,000		
Select Structural	2x12	1005	1155	1,200,000		
No.1		720	825	1,200,000		
No.2		720	825	1,100,000		
No.3		405	465	1,000,000		
<b>Douglas Fir–Larch</b>						
Select Structural	2x4	2500	2875	1,900,000	WCLIB WWPA	
No.1 & Btr		1985	2280	1,800,000		
No.1		1725	1985	1,700,000		
No.2		1510	1735	1,600,000		
No.3		865	990	1,400,000		
Stud		855	980	1,400,000		
Construction		1150	1325	1,500,000		
Standard		635	725	1,400,000		
Utility		315	365	1,300,000		
Select Structural		2x6	2170	2495		1,900,000
No.1 & Btr	1720		1975	1,800,000		
No.1	1495		1720	1,700,000		
No.2	1310		1505	1,600,000		
No.3	750		860	1,400,000		
Stud	775		895	1,400,000		
Select Structural	2x8	2000	2300	1,900,000		
No.1 & Str		1585	1825	1,800,000		
No.1		1380	1585	1,700,000		
No.2		1210	1390	1,600,000		
No.3		690	795	1,400,000		
Select Structural	2x10	1835	2110	1,900,000		
No.1 & Btr		1455	1675	1,800,000		
No.1		1265	1455	1,700,000		
No.2		1105	1275	1,600,000		
No.3	635	725	1,400,000			
Select Structural	2x12	1670	1920	1,900,000		
No.1 & Btr		1325	1520	1,800,000		
No.1		1150	1325	1,700,000		
No.2		1005	1155	1,600,000		
No.3		575	660	1,400,000		

Species and Grade	Size	Design Value in Bending, "Fb"		Modulus of Elasticity "E"	Grading Rules Agency
		Normal Duration	Snow Loading		
<b>Douglas Fir-Larch (North)</b>					
Select Structural	2x4	2245	2580	1,900,000	NLGA
No.1 /No.2		1425	1635	1,600,000	
No.3		820	940	1,400,000	
Stud		820	945	1,400,000	
Construction		1095	1255	1,500,000	
Standard		605	695	1,400,000	
Utility		290	330	1,300,000	
Select Structural	2x6	1945	2235	1,900,000	
No.1 /No.2		1235	1420	1,600,000	
No.3		710	815	1,400,000	
Stud		750	860	1,400,000	
Select Structural	2x8	1795	2065	1,900,000	
No.1 /No.2		1140	1310	1,600,000	
No.3		655	755	1,400,000	
Select Structural	2x10	1645	1890	1,900,000	
No.1 /No-2		1045	1200	1,600,000	
No.3		600	690	1,400,000	
Select Structural	2x12	1495	1720	1,900,000	
No.1 /No.2		950	1090	1,600,000	
No.3		545	630	1,400,000	
<b>Douglas Fir-South</b>					
Select Structural	2x4	2245	2580	1,400,000	WWPA
No.1		1555	1785	1,300,000	
No.2		1425	1635	1,200,000	
No.3		820	940	1,100,000	
Stud		820	945	1,100,000	
Construction		1065	1225	1,200,000	
Standard		605	695	1,100,000	
Utility		290	330	1,000,000	
Select Structural	2x6	1945	2235	1,400,000	
No.1		1345	1545	1,300,000	
No.2		1235	1420	1,200,000	
No.3		710	815	1,100,000	
Stud		750	860	1,100,000	
Select Structural	2x8	1795	2065	1,400,000	
No.1		1240	1430	1,300,000	
No.2		1140	1310	1,200,000	
No.3	655	755	1,100,000		
Select Structural	2x10	1645	1890	1,400,000	
No.1		1140	1310	1,300,000	
No.2		1045	1200	1,200,000	
No.3		600	690	1,100,000	
Select Structural	2x12	1495	1720	1,400,000	
No.1		1035	1190	1,300,000	
No.2		950	1090	1,200,000	
No.3	545	630	1,100,000		

Species and Grade	Size	Design Value in Bending, "Fb"		Modulus of Elasticity "E"	Grading Rules Agency
		Normal Duration	Snow Loading		
<b>Eastern Hemlock-Tamarack</b>					
Select Structural	2x4	2155	2480	1,200,000	NELMA NSLB
No.1		1335	1535	1,100,000	
No.2		990	1140	1,100,000	
No.3		605	695	900,000	
Stud		570	655	900,000	
Construction		775	895	1,000,000	
Standard		430	495	900,000	
Utility		200	230	800,000	
Select Structural		2x6	1870	2150	
No.1	1160		1330	1,100,000	
No.2	860		990	1,100,000	
No.3	525		600	900,000	
Stud	520		595	900,000	
Select Structural	2x8	1725	1985	1,200,000	
No.1		1070	1230	1,100,000	
No.2		795	915	1,100,000	
No.3		485	555	900,000	
Select Structural	2x10	1580	1820	1,200,000	
No.1		980	1125	1,100,000	
No.2		725	835	1,100,000	
No.3		445	510	900,000	
Select Structural	2x12	1440	1655	1,200,000	
No.1		890	1025	1,100,000	
No.2		660	760	1,100,000	
No.3		405	465	900,000	
<b>Eastern Softwoods</b>					
Select Structural	2x4	2155	2480	1,200,000	NELMA NSLB
No.1		1335	1535	1,100,000	
No.2		990	1140	1,100,000	
No.3		605	695	900,000	
Stud		570	655	900,000	
Construction		775	895	1,000,000	
Standard		430	495	900,000	
Utility		200	230	800,000	
Select Structural		2x6	1870	2150	
No.1	1160		1330	1,100,000	
No.2	860		990	1,100,000	
No.3	525		600	900,000	
Stud	520		595	900,000	
Select Structural	2x8	1725	1985	1,200,000	
No.1		1070	1230	1,100,000	
No.2		795	915	1,100,000	
No.3		485	555	900,000	
Select Structural	2x10	1580	1820	1,200,000	
No.1		980	1125	1,100,000	
No.2		725	835	1,100,000	
No.3		445	510	900,000	
Select Structural	2x12	1440	1655	1,200,000	
No.1		890	1025	1,100,000	
No.2		660	760	1,100,000	
No.3		405	465	900,000	

**SPS 320 to 325 APPENDIX A**

WISCONSIN ADMINISTRATIVE CODE

Species and Grade	Size	Design Value in Bending, "Fb"		Modulus of Elasticity "E"	Grading Rules Agency
		Normal Duration	Snow Loading		
<b>Eastern White Pine</b>					
Select Structural	2x4	2155	2480	1,200,000	NELMA NSLB
No.1		1335	1535	1,100,000	
No.2		990	1140	1,100,000	
No.3		605	695	900,000	
Stud		570	655	900,000	
Construction		775	895	1,000,000	
Standard		430	495	900,000	
Utility		200	230	800,000	
Select Structural	2x6	1870	2150	1,200,000	
No.1		1160	1330	1,100,000	
No.2		860	990	1,100,000	
No.3		525	600	900,000	
Stud		520	595	900,000	
Select Structural	2x8	1725	1985	1,200,000	
No.1		1070	1230	1,100,000	
No.2		795	915	1,100,000	
No.3		485	555	900,000	
Select Structural	2x10	1580	1820	1,200,000	
No.1		980	1125	1,100,000	
No.2		725	835	1,100,000	
No.3	445	510	900,000		
Select Structural	2x12	1440	1655	1,200,000	
No.1		890	1025	1,100,000	
No.2		660	760	1,100,000	
No.3		405	465	900,000	
<b>Hem Fir</b>					
Select Structural	2x4	2415	2775	1,600,000	WCLIB WWPA
No.1 & Btr		1810	2085	1,500,000	
No.1		1640	1885	1,500,000	
No.2		1465	1685	1,300,000	
No.3		865	990	1,200,000	
Stud		855	980	1,200,000	
Construction		1120	1290	1,300,000	
Standard		635	725	1,200,000	
Utility		290	330	1,100,000	
Select Structural	2x6	2095	2405	1,600,000	
No.1 & Btr		1570	1805	1,500,000	
No.1		1420	1635	1,500,000	
No.2		1270	1460	1,300,000	
No.3		750	860	1,200,000	
Stud		775	895	1,200,000	
Select Structural	2x8	1930	2220	1,600,000	
No.1 & Btr		1450	1665	1,500,000	
No.1		1310	1510	1,500,000	
No.2		1175	1350	1,300,000	
No.3	690	795	1,200,000		
Select Structural	2x10	1770	2035	1,600,000	
No.1 & Btr		1330	1525	1,500,000	
No.1		1200	1380	1,500,000	
No.2		1075	1235	1,300,000	
No.3		635	725	1,200,000	
Select Structural	2x12	1610	1850	1,600,000	
No.1 & Btr		1210	1390	1,500,000	
No.1		1095	1255	1,500,000	
No.2		980	1125	1,300,000	
No.3		575	660	1,200,000	

Species and Grade	Size	Design Value in Bending, "Fb"		Modulus of Elasticity "E"	Grading Rules Agency
		Normal Duration	Snow Loading		
<b>Hem-Fir (North)</b>					
Select Structural	2x4	2245	2580	1,700,000	NLGA
No.1 /No.2		1725	1985	1,600,000	
No.3		990	1140	1,400,000	
Stud		980	1125	1,400,000	
Construction		1325	1520	1,500,000	
Standard		720	825	1,400,000	
Utility		345	395	1,300,000	
Select Structural	2x6	1945	2235	1,700,000	
No.1 /No.2		1495	1720	1,600,000	
No.3		860	990	1,400,000	
Stud		890	1025	1,400,000	
Select Structural	2x8	1795	2065	1,700,000	
No.1 /No.2		1380	1585	1,600,000	
No.3		795	915	1,400,000	
Select Structural	2x10	1645	1890	1,700,000	
No.1 /No.2		1265	1455	1,600,000	
No.3		725	835	1,400,000	
Select Structural	2x12	1495	1720	1,700,000	
No.1 /No.2		1150	1325	1,600,000	
No.3		660	760	1,400,000	
<b>Mixed Maple</b>					
Select Structural	2x4	1725	1985	1,300,000	NELMA
No.1		1250	1440	1,200,000	
No.2		1210	1390	1,100,000	
No.3		690	795	1,000,000	
Stud		695	Boo	1,000,000	
Construction		920	1060	1,100,000	
Standard		520	595	1,000,000	
Utility		260	300	900,000	
Select Structural	2x6	1495	1720	1,300,000	
No.1		1085	1245	1,200,000	
No.2		1045	1205	1,100,000	
No.3		600	690	1,000,000	
Stud		635	725	1,000,000	
Select Structural	2x8	1380	1585	1,300,000	
No.1		1000	1150	1,200,000	
No.2		965	1110	1,100,000	
No.3		550	635	1,000,000	
Select Structural	2x10	1265	1455	1,300,000	
No.1		915	1055	1,200,000	
No.2		885	1020	1,100,000	
No.3		505	580	1,000,000	
Select Structural	2x12	1150	1325	1,300,000	
No.1		835	960	1,200,000	
No.2		805	925	1,100,000	
No.3		460	530	1,000,000	

Species and Grade	Size	Design Value in Bending, "Fb"		Modulus of Elasticity "E"	Grading Rules Agency
		Normal Duration	Snow Loading		
<b>Mixed Oak</b>					
Select Structural	2x4	1985	2280	1,100,000	NELMA
No.1		1425	1635	1,000,000	
No.2		1380	1585	900,000	
No.3		820	940	800,000	
Stud		790	910	800,000	
Construction		1065	1225	900,000	
Standard		605	695	800,000	
Utility		290	330	800,000	
Select Structural	2x6	1720	1975	1,100,000	
No.1		1235	1420	1,000,000	
No.2		1195	1375	900,000	
No.3		710	815	800,000	
Stud		720	825	800,000	
Select Structural	2x8	1585	1825	1,100,000	
No.1		1140	1310	1,000,000	
No.2		1105	1270	900,000	
No.3		655	755	800,000	
Select Structural	2x10	1455	1675	1,100,000	
No.1		1045	1200	1,000,000	
No.2		1010	1165	900,000	
No.3		600	690	800,000	
Select Structural	2x12	1325	1520	1,100,000	
No.1		950	1090	1,000,000	
No.2		920	1060	900,000	
No.3		545	630	800,000	
<b>Mixed Southern Pine</b>					
Select Structural	2x4	2360	2710	1,600,000	SPIB
No.1		1670	1920	1,500,000	
No.2		1500	1720	1,400,000	
No.3		865	990	1,200,000	
Stud		890	1020	1,200,000	
Construction		1150	1320	1,300,000	
Standard		635	725	1,200,000	
Utility		315	365	1,100,000	
Select Structural	2x6	2130	2450	1,600,000	
No.1		1490	1720	1,500,000	
No.2		1320	1520	1,400,000	
No.3		775	895	1,200,000	
Stud		775	895	1,200,000	
Select Structural	2x8	2010	2310	1,600,000	
No.1		1380	1590	1,500,000	
No.2		1210	1390	1,400,000	
No.3		720	825	1,200,000	
Select Structural	2x10	1730	1980	1,600,000	
No.1		1210	1390	1,500,000	
No.2		1060	1220	1,400,000	
No.3		605	695	1,200,000	
Select Structural	2x12	1610	1850	1,600,000	
No.1		1120	1290	1,500,000	
No.2		1010	1160	1,400,000	
No.3		575	660	1,200,000	

Species and Grade	Size	Design Value in Bending, "Fb"		Modulus of Elasticity "E"	Grading Rules Agency
		Normal Duration	Snow Loading		
<b>Northern Red Oak</b>					
Select Structural	2x4	2415	2775	1,400,000	NELMA
No.1		1725	1985	1,400,000	
No.2		1680	1935	1,300,000	
No.3		950	1090	1,200,000	
Stud		950	1090	1,200,000	
Construction		1265	1455	1,200,000	
Standard		720	825	1,100,000	
Utility		345	395	1,000,000	
Select Structural	2x6	2095	2405	1,400,000	
No.1		1495	1720	1,400,000	
No.2		1460	1675	1,300,000	
No.3		820	945	1,200,000	
Stud		865	990	1,200,000	
Select Structural	2x8	1930	2220	1,400,000	
No.1		1380	1585	1,400,000	
No.2		1345	1545	1,300,000	
No.3		760	875	1,200,000	
Select Structural	2x10	1770	2035	1,400,000	
No.1		1265	1455	1,400,000	
No.2		1235	1420	1,300,000	
No.3		695	800	1,200,000	
Select Structural	2x12	1610	1850	1,400,000	
No.1		1150	1325	1,400,000	
No.2		1120	1290	1,300,000	
No.3		635	725	1,200,000	
<b>Northern Species</b>					
Select Structural	2x4	1640	1885	1,100,000	NLGA
No.1 /No.2		990	1140	1,100,000	
No.3		605	695	1,000,000	
Stud		570	655	1,000,000	
Construction		775	895	1,000,000	
Standard		430	495	900,000	
Utility		200	230	900,000	
Select Structural		2x6	1420	1635	
No. 1 / No.2	860		990	1,100,000	
No.3	525		600	1,000,000	
Stud	520		595	1,000,000	
Select Structural	2x8	1310	1510	1,100,000	
No.1/No.2		795	915	1,100,000	
No.3		485	555	1,000,000	
Select Structural	2x10	1200	1380	1,100,000	
No.1 /No.2		725	835	1,100,000	
No.3		445	510	1,000,000	
Select Structural	2x12	1095	1255	1,100,000	
No.1 /No.2		660	760	1,100,000	
No.3		405	465	1,000,000	

Species and Grade	Size	Design Value in Bending, "Fb"		Modulus of Elasticity "E"	Grading Rules Agency
		Normal Duration	Snow Loading		
<b>Northern White Cedar</b>					
Select Structural	2x4	1335	1535	800,000	NELMA
No.1		990	1140	700,000	
No.2		950	1090	700,000	
No.3		560	645	600,000	
Stud		540	620	600,000	
Construction		720	825	700,000	
Standard		405	465	600,000	
Utility		200	230	600,000	
Select Structural	2x6	1160	1330	800,000	
No.1		860	990	700,000	
No.2		820	945	700,000	
No.3		485	560	600,000	
Stud		490	560	600,000	
Select Structural	2x8	1070	1230	800,000	
No.1		795	915	700,000	
No.2		760	875	700,000	
No.3		450	515	600,000	
Select Structural	2x10	980	1125	800,000	
No.1		725	835	700,000	
No.2		695	800	700,000	
No.3		410	475	600,000	
Select Structural	2x12	890	1025	800,000	
No.1		660	760	700,000	
No.2		635	725	700,000	
No.3		375	430	600,000	
<b>Red Maple</b>					
Select Structural	2x4	2245	2580	1,700,000	NELMA
No.1		1595	1835	1,600,000	
No.2		1555	1785	1,500,000	
No.3		905	1040	1,300,000	
Stud		885	1020	1,300,000	
Construction		1210	1390	1,400,000	
Standard		660	760	1,300,000	
Utility		315	365	1,200,000	
Select Structural	2x6	1945	2235	1,700,000	
No.1		1385	1590	1,600,000	
No.2		1345	1545	1,500,000	
No.3		785	905	1,300,000	
Stud		805	925	1,300,000	
Select Structural	2x8	1795	2065	1,700,000	
No.1		1275	1470	1,600,000	
No.2		1240	1430	1,500,000	
No.3		725	835	1,300,000	
Select Structural	2x10	1645	1890	1,700,000	
No.1		1170	1345	1,600,000	
No.2		1140	1310	1,500,000	
No.3		665	765	1,300,000	
Select Structural	2x12	1495	1720	1,700,000	
No.1		1065	1225	1,600,000	
No.2		1035	1190	1,500,000	
No.3		605	695	1,300,000	

Species and Grade	Size	Design Value in Bending, "Fb"		Modulus of Elasticity "E"	Grading Rules Agency
		Normal Duration	Snow Loading		
<b>Red Oak</b>					
Select Structural	2x4	1985	2280	1,400,000	NELMA
No.1		1425	1635	1,300,000	
No.2		1380	1585	1,200,000	
No.3		820	940	1,100,000	
Stud		790	910	1,100,000	
Construction		1065	1225	1,200,000	
Standard		605	695	1,100,000	
Utility		290	330	1,000,000	
Select Structural	2x6	1720	1975	1,400,000	
No.1		1235	1420	1,300,000	
No.2		1195	1375	1,200,000	
No.3		710	815	1,100,000	
Stud		720	825	1,100,000	
Select Structural	2x8	1585	1825	1,400,000	
No.1		1140	1310	1,300,000	
No.2		1105	1270	1,200,000	
No.3		655	755	1,100,000	
Select Structural	2x10	1455	1675	1,400,000	
No.1		1045	1200	1,300,000	
No.2		1010	1165	1,200,000	
No.3		600	690	1,100,000	
Select Structural	2x12	1325	1520	1,400,000	
No.1		950	1090	1,300,000	
No.2		920	1060	1,200,000	
No.3		545	630	1,100,000	

**SPS 320 to 325 APPENDIX A**

WISCONSIN ADMINISTRATIVE CODE

Species and Grade	Size	Design Value in Bending, "Fb"		Modulus of Elasticity "E"	Grading Rules Agency
		Normal Duration	Snow Loading		
<b>Redwood</b>					
Clear Structural	2x4	3020	3470	1,400,000	RIS
Select Structural		2330	2680	1,400,000	
Select Structural, open grain		1900	2180	1,100,000	
No.1		1680	1935	1,300,000	
No.1, open grain		1335	1535	1,100,000	
No.2		1595	1835	1,200,000	
No.2, open grain		1250	1440	1,000,000	
No.3		905	1040	1,100,000	
No.3, open grain		735	845	900,000	
Stud		725	835	900,000	
Construction		950	1090	900,000	
Standard		520	595	900,000	
Utility		260	300	800,000	
Clear Structural		2x6	2615	3010	
Select Structural	2020		2320	1,400,000	
Select Structural, open grain	1645		1890	1,100,000	
No.1	1460		1675	1,300,000	
No.1, open grain	1160		1330	1,100,000	
No.2	1385		1590	1,200,000	
No.2, open grain	1085		1245	1,000,000	
No.3	785		905	1,100,000	
No.3, open grain	635		730	900,000	
Stud	660		760	900,000	
Clear Structural	2x8	2415	2775	1,400,000	
Select Structural		1865	2140	1,400,000	
Select Structural, open grain		1520	1745	1,100,000	
No.1		1345	1545	1,300,000	
No.1, open grain		1070	1230	1,100,000	
No.2		1275	1470	1,200,000	
No.2, open grain		1000	1150	1,000,000	
No.3		725	835	1,100,000	
No.3, open grain	585	675	900,000		
Clear Structural	2x10	2215	2545	1,400,000	
Select Structural		1710	1965	1,400,000	
Select Structural, open grain		1390	1600	1,100,000	
No.1		1235	1420	1,300,000	
No.1, open grain		980	1125	1,100,000	
No.2		1170	1345	1,200,000	
No.2, open grain		915	1055	1,000,000	
No.3		665	765	1,100,000	
No.3, open grain	540	620	900,000		
Clear Structural	2x12	2015	2315	1,400,000	
Select Structural		1555	1785	1,400,000	
Select Structural, open grain		1265	1455	1,100,000	
No.1		1120	1290	1,300,000	
No.1, open grain		890	1025	1,100,000	
No.2		1065	1225	1,200,000	
No.2, open grain		835	960	1,000,000	
No.3		605	695	1,100,000	
No.3, open grain	490	560	900,000		

Species and Grade	Size	Design Value in Bending, "Fb"		Modulus of Elasticity "E"	Grading Rules Agency
		Normal Duration	Snow Loading		
<b>Southern Pine</b>					
Dense Select Structural	2x4	3510	4030	1,900,000	SPIB
Select Structural		3280	3770	1,800,000	
Non-Dense Select Structural		3050	3500	1,700,000	
No.1 Dense		2300	2650	1,800,000	
No.1		2130	2450	1,700,000	
No.1 Non-Dense		1950	2250	1,600,000	
No.2 Dense		1960	2250	1,700,000	
No.2		1720	1980	1,600,000	
No.2 Non-Dense		1550	1790	1,400,000	
No.3		980	1120	1,400,000	
Stud		1010	1160	1,400,000	
Construction		1270	1450	1,500,000	
Standard		720	825	1,300,000	
Utility		345	395	1,300,000	
Dense Select Structural		2x6	3100	3570	
Select Structural	2930		3370	1,800,000	
Non-Dense Select Structural	2700		3110	1,700,000	
No.1 Dense	2010		2310	1,800,000	
No.1	1900		2180	1,700,000	
No.1 Non-Dense	1720		1980	1,600,000	
No.2 Dense	1670		1920	1,700,000	
No.2	1440		1650	1,600,000	
No.2 Non-Dense	1320		1520	1,400,000	
No.3	865		990	1,400,000	
Stud	890	1020	1,400,000		
Dense Select Structural	2x8	2820	3240	1,900,000	
Select Structural		2650	3040	1,800,000	
Non-Dense Select Structural		2420	2780	1,700,000	
No.1 Dense		1900	2180	1,800,000	
No.1		1730	1980	1,700,000	
No.1 Non-Dense		1550	1790	1,600,000	
No.2 Dense		1610	1850	1,700,000	
No.2		1380	1590	1,600,000	
No.2 Non-Dense		1260	1450	1,400,000	
No.3		805	925	1,400,000	
Dense Select Structural	2x10	2470	2840	1,900,000	
Select Structural		2360	2710	1,800,000	
Non-Dense Select Structural		2130	2450	1,700,000	
No.1 Dense		1670	1920	1,800,000	
No.1		1500	1720	1,700,000	
No.1 Non-Dense		1380	1590	1,600,000	
No.2 Dense		1380	1590	1,700,000	
No.2		1210	1390	1,600,000	
No.2 Non-Dense		1090	1260	1,400,000	
No.3		690	795	1,400,000	
Dense Select Structural	2x12	2360	2710	1,900,000	
Select Structural		2190	2510	1,800,000	
Non-Dense Select Structural		2010	2310	1,700,000	
No.1 Dense		1550	1790	1,800,000	
No.1		1440	1650	1,700,000	
No.1 Non-Dense		1320	1520	1,600,000	
No.2 Dense		1320	1520	1,700,000	
No.2		1120	1290	1,600,000	
No.2 Non-Dense		1040	1190	1,400,000	
No.3		660	760	1,400,000	

Species and Grade	Size	Design Value in Bending, "Fb"		Modulus of Elasticity "E"	Grading Rules Agency
		Normal Duration	Snow Loading		
<b>Spruce-Pine-Fir</b>					
Select Structural	2x4	2155	2480	1,500,000	NLGA
No.1 /No.2		1510	1735	1,400,000	
No.3		865	990	1,200,000	
Stud		855	980	1,200,000	
Construction		1120	1290	1,300,000	
Standard		635	725	1,200,000	
Utility		290	330	1,100,000	
Select Structural	2x6	1870	2150	1,500,000	
No.1 /No.2		1310	1505	1,400,000	
No.3		750	860	1,200,000	
Stud		775	895	1,200,000	
Select Structural	2x8	1725	1985	1,500,000	
No. 1 / No.2		1210	1390	1,400,000	
No.3		690	795	1,200,000	
Select Structural	2x10	1580	1820	1,500,000	
No.1/No.2		1105	1275	1,400,000	
No.3		635	725	1,200,000	
Select Structural	2x12	1440	1655	1,500,000	
No.1 /No.2		1005	1155	1,400,000	
No.3		575	660	1,200,000	
<b>Spruce-Pine-Fir (South)</b>					
Select Structural	2x4	2245	2580	1,300,000	NELMA NSLB WCLIB WWPA
No.1		1465	1685	1,200,000	
No.2		1295	1490	1,100,000	
No.3		735	845	1,000,000	
Stud		725	835	1,000,000	
Construction		980	1125	1,000,000	
Standard		545	630	900,000	
Utility	260	300	900,000		
Select Structural	2x6	1945	2235	1,300,000	
No.1		1270	1460	1,200,000	
No.2		1120	1290	1,100,000	
No.3		635	730	1,000,000	
Stud	660	760	1,000,000		
Select Structural	2x8	1795	2065	1,300,000	
No.1		1175	1350	1,200,000	
No.2		1035	1190	1,100,000	
No.3	585	675	1,000,000		
Select Structural	2x10	1645	1890	1,300,000	
No.1		1075	1235	1,200,000	
No.2		950	1090	1,100,000	
No.3	540	620	1,000,000		
Select Structural	2x12	1495	1720	1,300,000	
No.1		980	1125	1,200,000	
No.2		865	990	1,100,000	
No.3	490	560	1,000,000		

Species and Grade	Size	Design Value in Bending, "Fb"		Modulus of Elasticity "E"	Grading Rules Agency
		Normal Duration	Snow Loading		
<b>Western Cedars</b>					
Select Structural	2x4	1725	1985	1,100,000	WCLIB WWPA
No.1		1250	1440	1,000,000	
No.2		1210	1390	1,000,000	
No.3		690	795	900,000	
Stud		695	800	900,000	
Construction		920	1060	900,000	
Standard		520	595	800,000	
Utility		260	300	800,000	
Select Structural	2x6	1495	1720	1,100,000	
No.1		1085	1245	1,000,000	
No.2		1045	1205	1,000,000	
No.3		600	690	900,000	
Stud	635	725	900,000		
Select Structural	2x8	1380	1585	1,100,000	
No.1		1000	1150	1,000,000	
No.2		965	1110	1,000,000	
No.3		550	635	900,000	
Select Structural	2x10	1265	1455	1,100,000	
No.1		915	1055	1,000,000	
No.2		885	1020	1,000,000	
No.3	505	580	900,000		
Select Structural	2x12	1150	1325	1,100,000	
No.1		835	960	1,000,000	
No.2		805	925	1,000,000	
No.3	460	530	900,000		
<b>Western Woods</b>					
Select Structural	2x4	1510	1735	1,200,000	WCLIB WWPA
No.1		1120	1290	1,100,000	
No.2		1120	1290	1,000,000	
No.3		645	745	900,000	
Stud		635	725	900,000	
Construction		835	960	1,000,000	
Standard		460	530	900,000	
Utility		230	265	800,000	
Select Structural	2x6	1310	1505	1,200,000	
No.1		970	1120	1,100,000	
No.2		970	1120	1,000,000	
No.3		560	645	900,000	
Stud	575	660	900,000		
Select Structural	2x8	1210	1390	1,200,000	
No.1		895	1030	1,100,000	
No.2		895	1030	1,000,000	
No.3	520	595	900,000		
Select Structural	2x10	1110	1275	1,200,000	
No.1		820	945	1,100,000	
No.2		820	945	1,000,000	
No.3	475	545	900,000		
Select Structural	2x12	1005	1155	1,200,000	
No.1		750	860	1,100,000	
No.2		750	860	1,000,000	
No.3	430	495	900,000		

**SPS 320 to 325 APPENDIX A**

WISCONSIN ADMINISTRATIVE CODE

Species and Grade	Size	Design Value in Bending, "Fb"		Modulus of Elasticity "E"	Grading Rules Agency
		Normal Duration	Snow Loading		
<b>White Oak</b>					
Select Structural	2x4	2070	2380	1,100,000	NELMA
No.1		1510	1735	1,000,000	
No.2		1465	1685	900,000	
No.3		820	940	800,000	
Stud		820	945	800,000	
Construction		1095	1255	900,000	
Standard		605	695	800,000	
Utility		290	330	800,000	
Select Structural		2x6	1795	2065	
No.1	1310		1505	1,000,000	
No.2	1270		1460	900,000	
No.3	710		815	800,000	
Stud	750		860	800,000	
Select Structural	2x8	1655	1905	1,100,000	
No.1		1210	1390	1,000,000	
No.2		1175	1350	900,000	
No.3		655	755	800,000	
Select Structural	2x10	1520	1745	1,100,000	
No.1		1105	1275	1,000,000	
No.2		1075	1235	900,000	
No.3		600	690	800,000	
Select Structural	2x12	1380	1585	1,100,000	
No.1		1005	1155	1,000,000	
No.2		980	1125	900,000	
No.3		545	630	800,000	
<b>Yellow Poplar</b>					
Select Structural	2x4	1725	1985	1,500,000	NSLB
No.1		1250	1440	1,400,000	
No.2		1210	1390	1,300,000	
No.3		690	795	1,200,000	
Stud		695	800	1,200,000	
Construction		920	1060	1,300,000	
Standard		520	595	1,100,000	
Utility		230	265	1,100,000	
Select Structural		2x6	1495	1720	
No.1	1055		1245	1,400,000	
No.2	1045		1205	1,300,000	
No.3	600		690	1,200,000	
Stud	635		725	1,200,000	
Select Structural	2x8	1380	1585	1,500,000	
No.1		1000	1150	1,400,000	
No.2		965	1110	1,300,000	
No.3		550	635	1,200,000	
Select Structural	2x10	1265	1455	1,500,000	
No.1		915	1055	1,400,000	
No.2		885	1020	1,300,000	
No.3		505	580	1,200,000	
Select Structural	2x12	1150	1325	1,500,000	
No.1		835	960	1,400,000	
No.2		805	925	1,300,000	
No.3		460	530	1,200,000	

### 321.04 (3) (b) 5. HANDRAIL SHAPES

#### ROUND

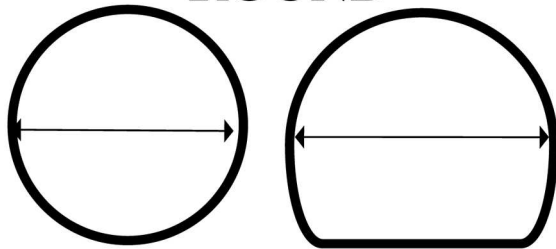

**MAXIMUM 2"  
DIAMETER**

#### RECTANGULAR

OK (w x ht):  
1/2" x 2 5/8"  
3/4" x 2 1/2"  
1" x 2 3/8"  
1 1/8" x 2 5/16"  
1 1/2" x 2 1/8"  
1 7/8" x 1 15/16"

OK (w x ht):  
2" x 1 7/8"  
2 1/2" x 1 5/8"  
2 3/4" x 1 1/2"  
2 7/8" x 1/2" to 1 7/16"

**MAXIMUM 2 7/8"  
CROSS SECTION**

**Maximum 6 1/4"  
gripping surface  
including  
minimum 1/4" recess  
on each side**

#### OTHERS

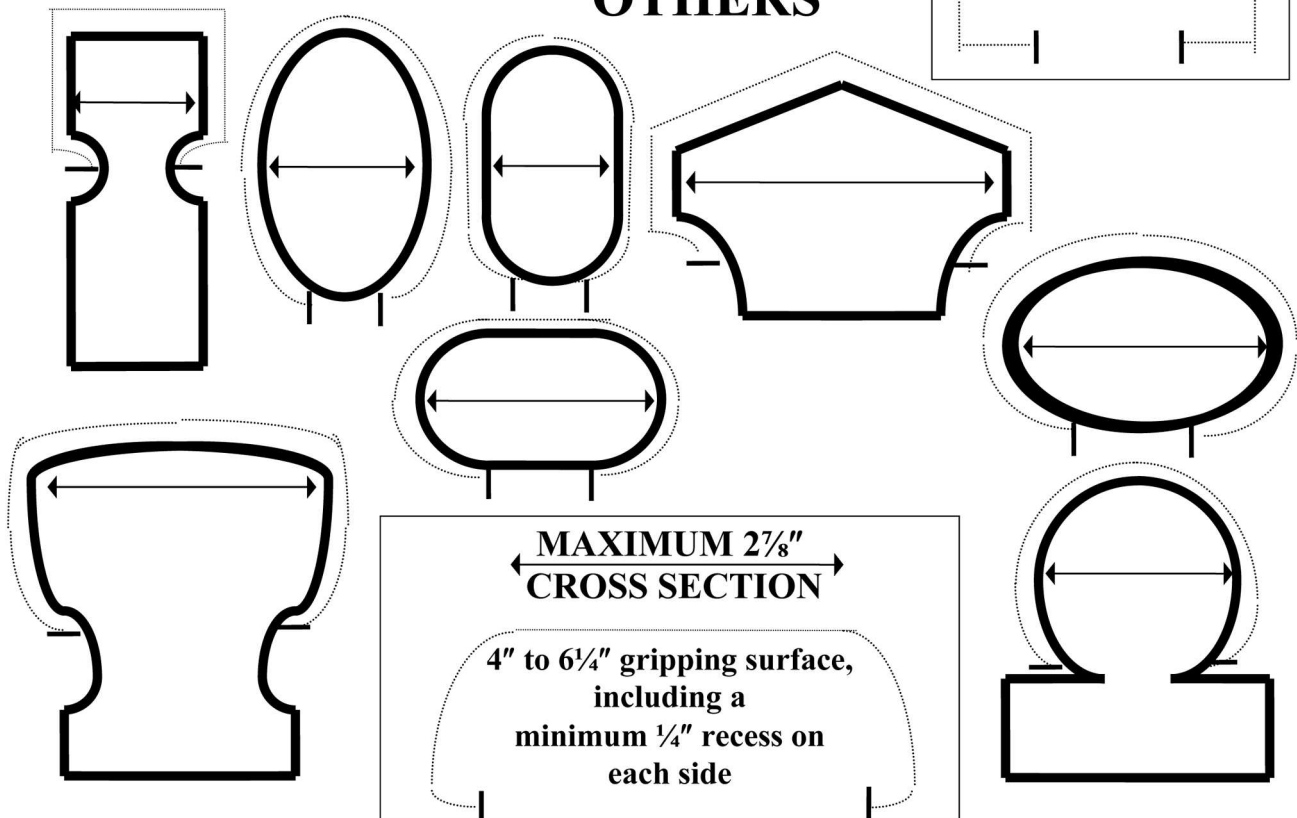

**321.125 (3) CONTROL STANDARDS**

The following are designs acceptable by the department to achieve compliance with the control standards of acceptable soil loss or percent reduction of sediment load in runoff from a site.

**Less than one acre disturbance (regardless of the lot or property size).****A. Mandated practices:**

1. A method to prevent or reduce soil from leaving a site via entries or roads. This may include a tracking pad or tire washing stand designed and installed to meet DNR Standard 1057. Other means of compliance include a gravel mulch, frozen soil, bedrock or some other physical means to prevent soil from leaving the site on vehicle tires which is equivalent to the tracking pad or tire washing stand.
2. Storm water inlet protection. Inlet protection may be accomplished by using DNR Technical Standard, number 1050, "Storm Drain Inlet Protection for Construction Sites". The protection of stormwater inlets in the code is specific to "on-site" inlets; however an off-site inlet may create a direct conduit to a water of the state, which links any inlet that leads to a water of the state to the #3 mandated practice. In that case, special care should be taken to protect both types of inlets from sediment in runoff from a construction site.
3. Protection of adjoining waters of the state. The installation of practices is necessary if runoff from the disturbance could impact a water of the state. Practices may include channel erosion mats, silt fences, vegetative buffers or any other practices applicable to the specific site.
4. Drainage way protection. Any ditches or drainage ways that flow off-site must be protected with appropriate best management practices (BMPs). This may include but is not limited to ditch checks, channel erosion control mats or riprap.
5. Dewatering activity sediment reduction. Any dewatering necessary on the construction site must include measures to reduce the sediment in the water leaving the site. Dewatering BMPs may include filters, fiber rolls or gravel bag berms.
6. Stockpile protection. Any soil stockpiles which are left more than 7 days must be protected by seeding and mulching, erosion mat, silt fencing, covering or other methods. This does not include fill or topsoil piles that are in active use.

**B. In addition to mandated practices, the owner/contractor or designer must choose one or more of the following methods in order to achieve compliance with the standards.**

1. The Revised Universal Soil Loss Equation may be used to determine the amount of soil lost from a site in order to stay below the 5 tons/acre/year for sand, loamy sand, sandy loam, loam, sandy clay loam, clay loam, sandy clay, silty clay or clay textures or the 7.5 tons/acre/year soil loss for silt, silty clay loam or silt loam textures. The Department-accepted version of an Excel worksheet that is used to calculate the soil loss is available at: <http://dsps.wi.gov/Default.aspx?Page=224e686e-b2b6-44ac-b79d-d8ad3d3cb560>.
2. Silt fence may be placed in accordance with the DNR Technical Standard 1056 and remain on the site until the previous area is stabilized. This practice, in addition to the mandated practices in part "A" is accepted by the Department of Safety and Professional Services as compliant with the 40% reduction in sediment load goal.
3. The site may be seeded and mulched, erosion control mat may be installed or polymers may be applied. The erosion control BMPs must be applied within one week of disturbance. Seeding must be accomplished in accordance with DNR Technical Standard 1059 and mulching with DNR Technical Standard 1058. Erosion control mat must be installed in accordance with DNR Technical Standards 1052 and 1053. Polymer application must be done in accordance with DNR Technical Standard 1051. This method is only acceptable when the maximum slope length is 300 feet and the maximum slope is no more than that specified in Table A-321.125-1 and Table A-321.125-2.
4. Practices may be included in the erosion and sediment control plan for the site that achieve compliance with the 40% reduction in sediment load in the runoff from the site. Table A-321.125-3 lists several erosion and sediment control BMPs and the USEPA (United States Environmental Protection Agency) efficiency rating for that BMP.
5. A unique design may be submitted with the UDC permit application for review.

**Table A-321.125-1****Slope Limitations for Permissible Soil Loss with max. 300' slope length<sup>1</sup>****When sites are seeded, mulched or otherwise stabilized within one week of disturbance<sup>2</sup>**

Soil Texture	Jan	Feb	Mar	Apr	May	June	July	Aug	Sept	Oct	Nov	Dec
<b>7.5 tons/acre/year allowable soil loss</b>												
Silt loam or Silty clay loam	20%	20%	16%	9%	6%	5%	6%	8%	12%	17%	20%	20%
<b>5 tons/acre/year allowable soil loss</b>												
Sand	20%	20%	20%	14%	10%	8%	9%	12%	19%	20%	20%	20%
Loamy sand	20%	20%	20%	13%	9%	8%	9%	11%	17%	20%	20%	20%
Sandy loam	20%	20%	16%	9%	7%	5%	6%	8%	16%	17%	20%	20%
Loam, Sandy clay loam, Clay loam, Sandy clay	20%	20%	13%	8%	5%	4%	5%	6%	10%	17%	20%	20%
Silty clay	20%	20%	16%	9%	7%	5%	6%	8%	13%	17%	20%	20%
Clay	20%	20%	15%	9%	6%	5%	5%	7%	12%	16%	20%	20%

<sup>1</sup> The information in the table is derived from Grant County rainfall information and the use of the Revised Universal Soil Loss Equation. The slope limitation refers to the maximum slope permitted in order to achieve code compliance for the site specifics in the table. Opening date is the 15th of each month and closing is the 22nd. End date is 60 days past closing date.

<sup>2</sup> Stabilization may be accomplished by temporary seeding and mulching, permanent seeding and mulching, application of polymers or placement of erosion control mats. Additionally, the mandated practices specific to the site must be in place.

**Table A-321.125-2****Slope Limitations for Permissible Soil Loss with max. 300' slope length<sup>1</sup>****When sites are seeded, mulched or otherwise stabilized within 4 weeks of disturbance<sup>2</sup>**

Soil Texture	Jan	Feb	Mar	Apr	May	June	July	Aug	Sept	Oct	Nov	Dec
<b>7.5 tons/acre/year allowable soil loss</b>												
Silt loam or Silty clay loam	18%	11%	8%	4%	3%	2%	3%	4%	6%	10%	15%	20%
<b>5 tons/acre/year allowable soil loss</b>												
Sand	20%	20%	17%	12%	7%	5%	4%	4%	6%	10%	15%	20%
Loamy sand	20%	20%	16%	11%	6%	4%	4%	4%	5%	9%	14%	20%
Sandy loam	20%	18%	11%	8%	4%	3%	2%	3%	4%	6%	10%	16%
Loam, Sandy clay loam, Clay loam, Sandy clay	20%	9%	6%	4%	2%	2%	4%	3%	5%	8%	13%	20%
Silty clay	18%	11%	8%	4%	3%	2%	4%	6%	6%	10%	15%	20%
Clay	17%	11%	7%	4%	3%	2%	4%	6%	6%	9%	14%	20%

<sup>1</sup> The information in the table is derived from Grant County rainfall information and the use of the Revised Universal Soil Loss Equation. The slope limitation refers to the maximum slope permitted in order to achieve code compliance for the site specifics in the table. Opening date is the 15th of each month and closing is the 15th of the following month. End date is 60 days past closing date.

<sup>2</sup> Stabilization may be accomplished by temporary seeding and mulching, permanent seeding and mulching, application of polymers or placement of erosion control mats. Additionally, the mandated practices specific to the site must be in place.

**Erosion and sediment control for construction sites having a land-disturbance area of one acre or more is regulated by the Department of Natural Resources**

**Table A-321.125-3**  
**Erosion/Sediment Control BMP Efficiency<sup>1</sup>**

Practice	Type of Practice	Standard Number <sup>2</sup>	Recognized Efficiency
Straw Bales	Sediment Control	1055	10% <sup>4</sup>
Fiber Rolls	Sediment Control		40%
Sediment Traps	Sediment Control	1063	40%
Silt Fence	Sediment Control	1056	Sand 80% Other soils 40%
Compost Blankets	Erosion Control	See std 1058 for Wisconsin	80%
Polymers	Erosion Control	1050	80%
Sodding	Erosion Control		80%
Seeding	Erosion Control	1059	80%
Mulching	Erosion Control	1058	80%
Non channel control mat	Erosion Control	1052	80% <sup>3</sup>

<sup>1</sup> BMP efficiency is derived from information provided on the Environmental Protection Construction Erosion Control website in August, 2006 and only when the BMP is installed per the listed standard.

<sup>2</sup> Standard number refers to the Wisconsin Department of Natural Resources Conservation Practice Standard number.

<sup>3</sup> This efficiency measure is provided by the Department of Safety and Professional Services, Industry Services Division.

<sup>4</sup> This efficiency measure is provided by the Department of Safety and Professional Services, Industry Services Division, and only for a short duration as described in the standard.

There are several BMPs that do not have an efficiency assigned by the EPA. These include mandatory controls such as inlet protection, drainage way protection (riprap) and tracking pads. Diversions, both temporary and permanent are also not included in Table A-321.125-2. Diversions impact the erosion on a site by shortening the length of slope in the Revised Universal Soil Loss Equation (RUSLE).

Following is an example of an erosion and sediment control plan (Figure A-321.125). This plan may be used for reference, however each site is unique and each plan will address the site-specific issues.

Figure A-325.125-1

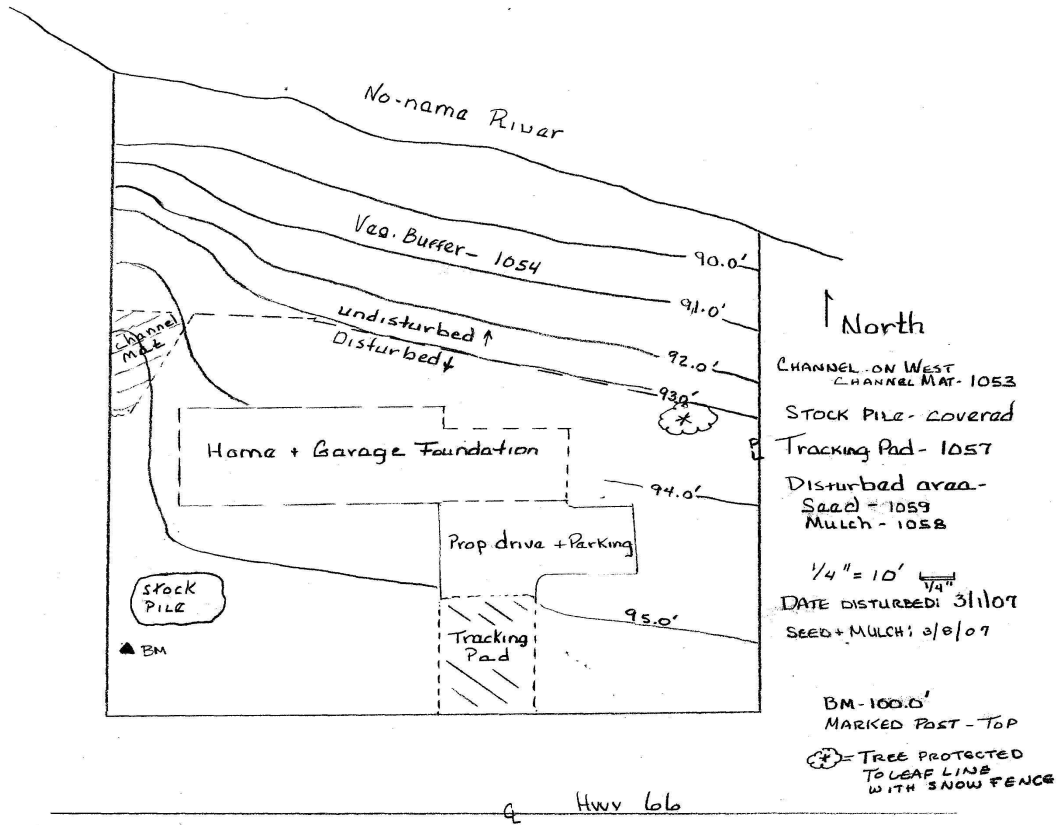

**Figure A-325.125-2**  
**Sample Page from Erosion Control Checklist**

Y	N	N/A	<b>Seeding for Erosion Control – 1059</b>
			Topsoil depth 2 inches for temporary seeding?
			Topsoil depth 4 inches for permanent seeding?
			Rocks, twigs and foreign material removed?
			Clods < 2 inch?
			Seed sown < 1/4 inch deep?
			Temporary species and rates per table?

Species	Lbs/Acre	% Purity	Season
Oats	131	98	Spring & Summer
Cereal Rye	131	97	Fall
Winter Wheat	131	95	Fall
Annual Ryegrass	80	97	Fall

Y	N	N/A	<b>Mulching for Construction Sites 1058</b>
			Area under mulch free of gullies and rills?
			Mulch not in concentrated flow channels?
			Erosion occurring in mulched areas?
			Natural biodegradable materials?
			Free of toxic, noxious or diseased substances?
			Marsh hay only on upland sites?
			Crimped straw or hay fiber length > 6 inches?
			No bark or wood chips on seeded sites?
			Mulch covers 80% of unseeded areas?
			Mulch covers 70% of seeded areas?
			Mulch 1/2 to 1-1/2 inches thick in seeded areas?
			Mulch 1-1/2 to 3 inches thick for unseeded areas?
			Wood chips 1/2 to 1-1/2 inches thick?
			Mulch anchors w/crimping, matting and tackifier?

**Note:** The entire checklist can be found at: <http://dps.wi.gov/Default.aspx?Page=224e686e-b2b6-44ac-b79d-d8ad3d3cb560>.

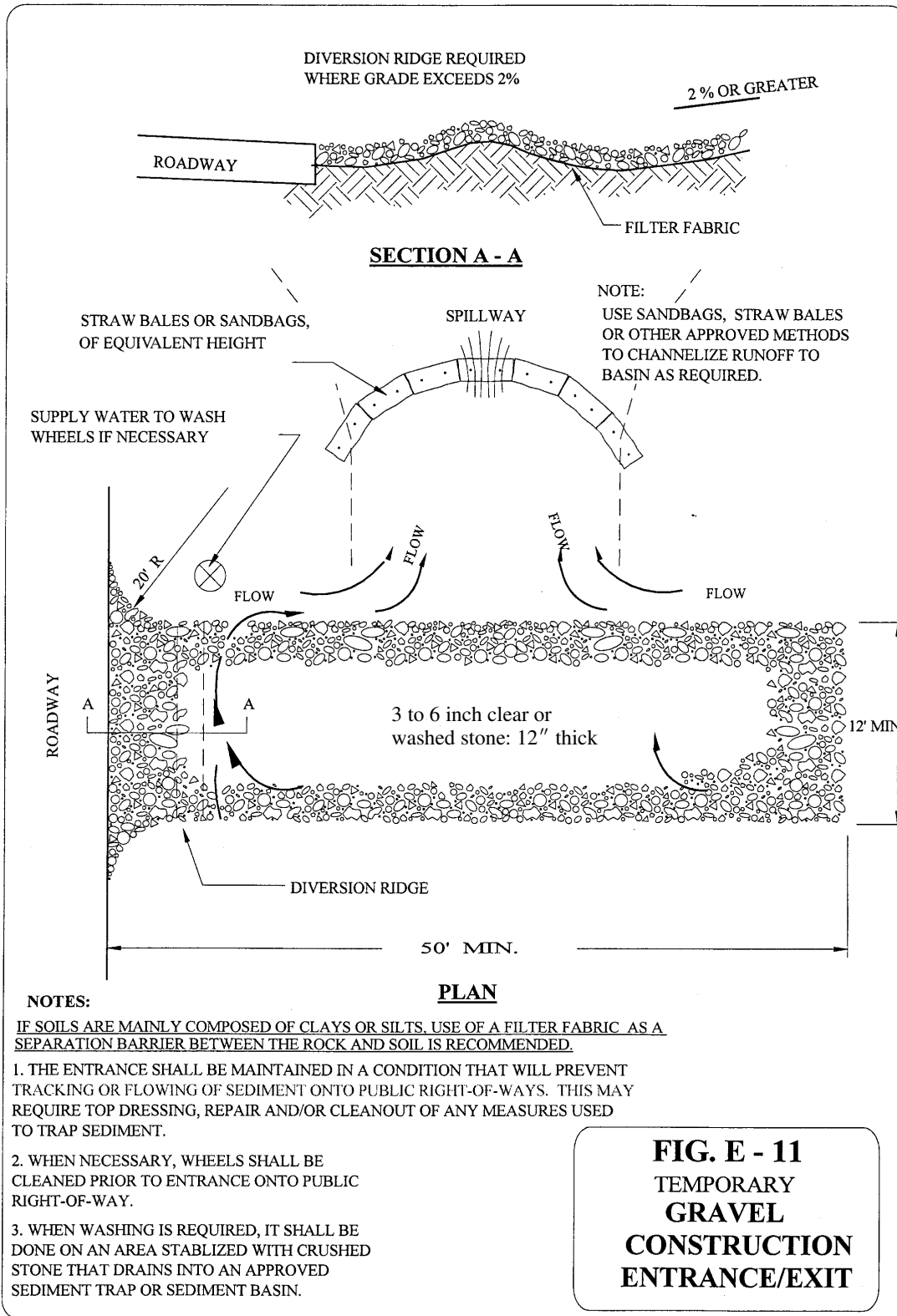

Also see Standard 1060 for additional information.

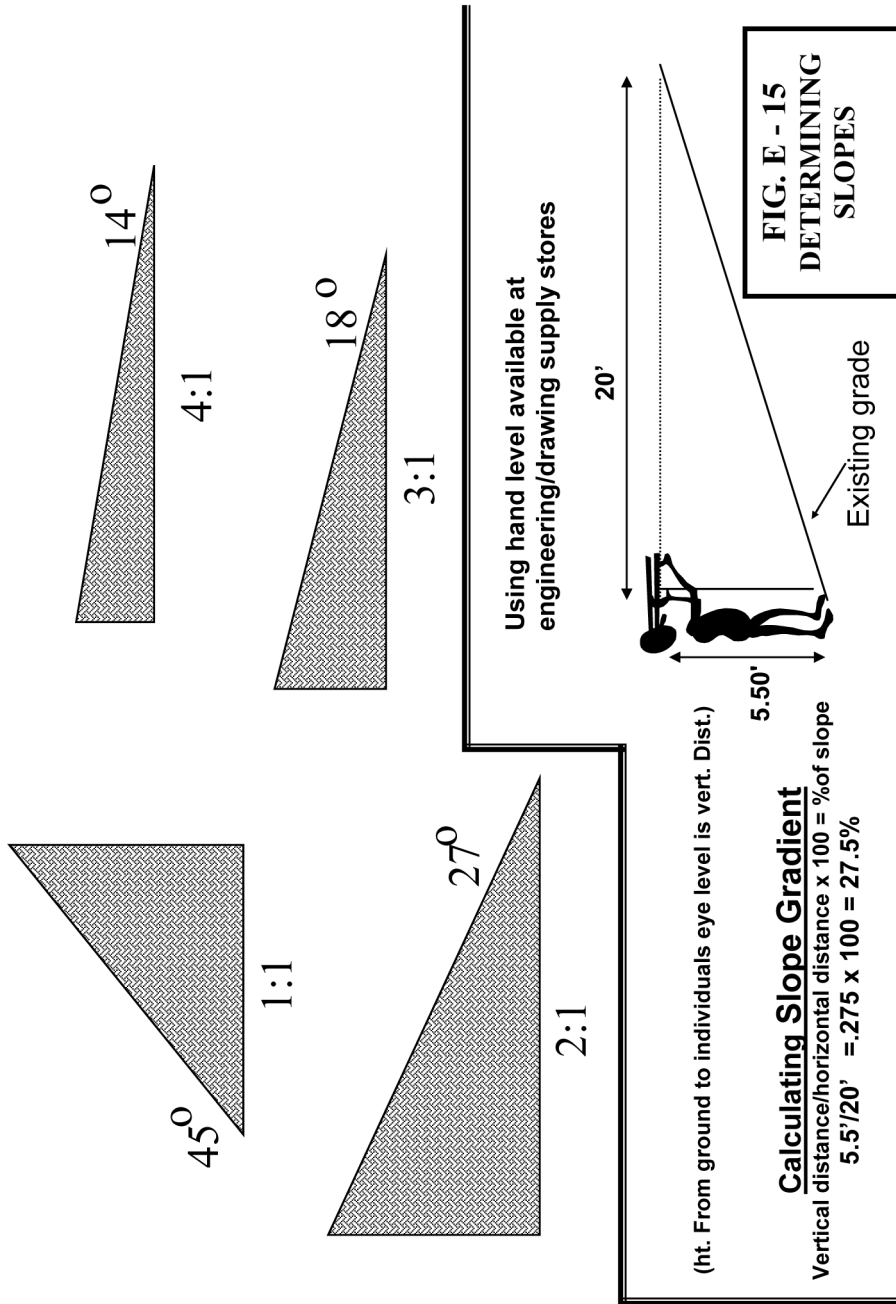

Following are reprints of the DNR Erosion Control Technical Standards, also available at

<http://www.dnr.state.wi.us/runoff/stormwater/techstds.htm>

STANDARD	Number	Effective Date	Page
Channel Erosion Mat	1053	08/05	156
De-watering	1061	04/07	159
Ditch Checks	1062	03/06	166
Construction Site Diversion	1066	03/06	170
Dust Control	1068	03/04	172
Grading Practices for Erosion Control — Temporary	1067	03/04	173
Interim Sediment Control: Water Application of Polymers	1051	11/02	175
Land Application of Anionic Polyacrylamide	1050	07/01	185
Mulching for Construction Sites	1058	06/03	188
Non-channel Erosion Mat	1052	08/03	191
Sediment Bale Barrier	1055	08/03	194
Sediment Basin	1064	03/06	196
Sediment Trap	1063	09/05	205
Seeding	1059	11/03	209
Silt Fence	1056	03/06	213
Silt Curtain	1070	09/05	218
Stone Tracking Pad and Tire Washing	1057	08/03	221
Storm Drain Inlet Protection for Construction Sites	1060	10/03	223
Turbidity Barriers	1069	09/05	227
Vegetative Buffer for Construction Sites	1054	05/03	232

## Channel Erosion Mat

### 1053 (8/05)

Wisconsin Department of Natural Resources

Conservation Practice Standard

**Note:** Words in the standard that are shown in italics are described in XI. Definitions. The words are italicized the first time they are used.

#### I. Definition

A protective soil cover of straw, wood, coconut fiber or other suitable plant residue, or plastic fibers formed into a mat, usually with a plastic or biodegradable mesh on one or both sides. Erosion mats are rolled products available in many varieties and combination of materials and with varying life spans.

#### II. Purpose

The purpose of this practice is to protect the channel from erosion or act as turf reinforcement during and after the establishment of grass or other vegetation in a channel. This practice applies to both *Erosion Control Revegetative Mats (ECRM<sup>1</sup>)* and *Turf-Reinforcement Mats (TRM)*.

#### III. Conditions Where Practice Applies

This standard applies where runoff channelizes in intermittent flow and vegetation is to be established. Some products may have limited applicability in projects adjacent to navigable waters.

#### IV. Federal, State, and Local Laws

Users of this standard shall be aware of applicable federal, state, and local laws, rules, regulations, or permit requirements governing the use and placement of erosion mat. This standard does not contain the text of federal, state, or local laws.

#### V. Criteria

This section establishes the minimum standards for design, installation and performance requirements. To complete the shear calculations, a 2 year, 24 hour storm event shall be used to calculate depth of flows for an ECRM. For sizing a TRM, use the depth of flow corresponding to the maximum design capacity of the channel.

Only mats listed in the Wisconsin Department of Transportation (WisDOT) Erosion Control Product Acceptability List (PAL) will be accepted for use in this standard.

To differentiate applications WisDOT organizes erosion mats into three classes of mats, which are further broken down into various Types.

- A. Class I: A short-term duration (minimum of 6 months), light duty, organic ECRM with plastic or biodegradable netting.
  - 1. Type A – Only suitable for slope applications, not channel applications.
  - 2. Type B – Double netted product for use in channels where the calculated (design) shear stress is 1.5 lbs/ft<sup>2</sup> or less.
- B. Class II: A long-term duration (three years or greater), organic ECRM.
  - 1. Type A – Jute fiber only for use in channels to reinforce sod.
  - 2. Type B – For use in channels where the calculated (design) shear stress is 2.0 lbs/ft<sup>2</sup> or less. Made with plastic or biodegradable mat.
  - 3. Type C – A woven mat of 100% organic material for use in channels where the calculated (design) shear stress is 2.0 lbs/ft<sup>2</sup> or less. Applicable for use in environmentally sensitive areas where plastic netting is inappropriate.

- C. Class III: A permanent 100% synthetic ECRM or TRM. Class I, Type B erosion mat or Class II, Type B or C erosion mat must be placed over a soil filled TRM.
1. Type A – An ECRM for use in channels where the calculated (design) shear stress of 2.0 lbs/ft<sup>2</sup> or less.
  2. Type B – A TRM for use in channels where the calculated (design) shear stress of 2.0 lbs/ft<sup>2</sup> or less.
  3. Type C – A TRM for use in channels where the calculated (design) shear stress of 3.5 lbs/ft<sup>2</sup> or less.
  4. Type D – A TRM for use in channels where the calculated (design) shear stress of 5.0 lbs/ft<sup>2</sup> or less.

## VI. Installation

- A. ECRM shall be installed after all topsoiling, fertilizing, liming, and seeding is complete.
- B. Erosion mats shall extend for whichever is greater: upslope one-foot minimum vertically from the ditch bottom or 6 inches higher than the design flow depth.
- C. The mat shall be in firm and continuous contact with the soil. It shall be anchored, overlapped, staked and entrenched per the manufacturer's recommendations.
- D. TRM shall be installed in conjunction with the topsoiling operation and shall be followed by ECRM installation.
- E. At time of installation, document the manufacturer and mat type by saving material labels and manufacturer's installation instructions. Retain this documentation until the site is stabilized.

## VII. Considerations

- A. Erosion mats shall be selected so that they last long enough for the grass or other vegetation to become densely established.
- B. Consider using Class II, Type C mats adjacent to waterways where trapping small animals is to be avoided.
- C. Class III TRM may be appropriate as a replacement for riprap as a channel liner. Check the shear stress criteria for the channel to determine mat applicability.
- D. Once a gully has formed in a channel, it is difficult to stabilize due to loss of soil structure. Even when the gully is filled with topsoil and reseeded, the soil has a tendency to dislodge in the same pattern. If gully formation continues to be a problem the design should be reevaluated, including other mat classes or riprap.
- E. It may be difficult to establish permanent vegetation and adequate erosion protection in a channel with continuous flow. Consider riprap or planting wetland species with an ECRM.
- F. Documentation of materials used, monitoring logs, project diary, and weekly inspection forms including erosion and stormwater management plans, should be provided to the authority charged with long term maintenance of the site.
- G. Channel cross sections may be parabolic, v-shaped or trapezoidal. The use of "V" channels is generally discouraged due to erosion problems experienced.
- H. To help determine the appropriate channel liner, designers can refer to the design matrix in the back of the WisDOT PAL. However, for channels not conforming to the typical section shown in the channel matrix or having a depth of flow greater than 6 inches (150 mm), the designer will need to design for an appropriate channel liner. One way to do this is to use the "tractive force" method presented in FHWA's Hydraulic Engineering Circular (HEC) No. 15. This method requires that the calculated maximum shear stress of a channel is not to exceed the permissible shear stress of the channel liner. To use this method, permissible shear stress values are stated next to each device listed in the channel matrix.

### VIII. Plans and Specifications

- A. Plans and specifications for installing erosion mat shall be in keeping with this standard and shall describe the requirements for applying the practice to achieve its intended purpose. The plans and specifications shall address the following:
  - 1. Location of erosion mat
  - 2. Installation sequence
  - 3. Material specification conforming to standard
- B. All plans, standard detail drawings, or specifications shall include schedule for installation, inspection, and maintenance. The responsible party shall be identified.

### IX. Operation and Maintenance

- A. Erosion mats shall at a minimum be inspected weekly and within 24 hours after every precipitation event that produces 0.5 inches of rain or more during a 24-hour period.
- B. If there are signs of rilling under the mat, install more staples or more frequent anchoring trenches. If rilling becomes severe enough to prevent establishment of vegetation, remove the section of mat where the damage has occurred. Fill the eroded area with topsoil, compact, reseed and replace the section of mat, trenching and overlapping ends per manufacturer's recommendations. Additional staking is recommended near where rilling was filled.
- C. If the reinforcing plastic netting has separated from the mat, remove the plastic and if necessary replace the mat.
- D. Maintenance shall be completed as soon as possible with consideration to site conditions.

### X. References

WisDOT "Erosion Control Product Acceptability List" is available online at <http://www.dot.wisconsin.gov/business/engrserv/pal.htm>.

### XI. Definitions

*Channel Erosion:* The deepening and widening of a channel due to soil loss caused by flowing water. As rills become larger and flows begin to concentrate, soil detachment occurs primarily as a result of shear.

*Erosion Control Revegative Mats (ECRM) (II):* Erosion control revegetative mats are designed to be placed on top of soil.

*Turf-Reinforcement Mats (TRM) (II):* Turf-reinforcement mats are permanent devices constructed from various types of synthetic materials and buried below the surface to help stabilize the soil. TRMs must be used in conjunction with an ECRM or an approved soil stabilizer Type A (as classified in the WisDOT PAL)

## Dewatering

### 1061 (4/07)

#### Wisconsin Department of Natural Resources Conservation Practice Standard

**Note:** Words in the standard that are shown in italics are described in X. Definitions. The words are italicized the first time they are used.

#### I. Definition

A compartmented container, settling basin, filter, or other appropriate best management practice through which sediment-laden water is conveyed to trap and retain the sediment.

#### II. Purposes

The purpose of this standard is to determine appropriate methods and means to remove sediment from water generated during dewatering activities prior to discharging off-site or to waters of the state. Practices identified in this standard shall be deemed to meet the de-watering performance standard to prevent the discharge of sediment to the maximum extent practicable (MEP) as defined in s. NR 151.11 (6) (c).

#### III. Conditions where Practice Applies

This practice applies where sediment laden water needs to be removed for construction or maintenance activities. Dewatering practices shall be in keeping with the effective operating and applicability criteria listed on Figure 2, Dewatering Practice Selection Matrix.

This practice does not apply to:

- Water being discharged directly to groundwater or *karst features*<sup>1</sup>. Refer to NR140
- Well dewatering systems. Refer to NR 812

#### IV. Federal, State, and Local Laws

Users of this standard shall be aware of applicable federal, state, and local laws, rules, regulations, or permit requirements governing the use and placement of this practice. This may include activities performed under NR 216 and Chapter 30 permits, for water bodies with *targeted performance standards* per NR 151.004, 303d waterbodies or others. This standard does not contain the text of federal, state, or local laws.

#### V. Criteria

This section establishes the minimum allowable limits for design parameters, installation and performance requirements.

Dewatering practices shall be selected based on the predominant soil texture encountered at the dewatering site with consideration given to pumping or flow rates, volumes and device effectiveness. Refer to Figure 1 USDA Soil textural triangle to assist with soil classifications at the site. Figure 2, Dewatering Practice Selection Matrix illustrates acceptable dewatering options and their effective ranges. Practices selected that are not on the matrix must provide an equivalent level of control, with justification provided to the reviewing authority.

- A. Site Assessment – A site assessment shall be conducted and documented to determine the physical site characteristics that will affect the placement, design, construction and maintenance of dewatering activities. The site assessment shall identify characteristics such as ground slopes, soil types, soil conditions, bedrock, sinkholes, drainage patterns, runoff constituents, proximity to regulated structures, natural resources, and specific land uses. The site assessment shall include the following:
  - Sanitary and storm sewer locations
  - Potential contamination – Odor or discoloration other than sediment, or an oily sheen on the surface of the sediment laden water. If contamination is present, notify DNR Spills Reporting
  - Soil textural class for areas where dewatering will occur. Soil investigation shall extend below grading and trenching activities
  - Depth to the seasonally highest water table
  - Discharge outfall locations
  - Distance and conveyance method to receiving waters

### B. General Criteria Applicable To All Dewatering Activities

1. Contact the WDNR when the discharge from a dewatering practice will enter a WDNR listed *Exceptional Resource Water (ERW)*, *Outstanding Resource Water (ORW)*, or a wetland in an area of special natural resource interest as identified in NR 103.
2. Contact the owner or operator of the municipal separate stormwater system if the discharge is to a municipal storm water conveyance system. The allowable discharge rate shall be limited by the capacity of the system or requirements of the system owner.
3. When practical, dewatering effluent shall be collected in a pump truck for transport to a *treatment facility* or discharged directly to a treatment facility.
4. For surface dewatering, utilize a floating suction hose, or other method, to minimize sediment being sucked off the bottom.
5. For discharges that will be directed to locations on-site verify that the anticipated volume of water can be fully contained.
6. The topography and condition of the ground cover between the pump discharge point and potential receiving waters shall be evaluated for potential erosion. Appropriate stabilization measures shall be incorporated to prevent erosion.
7. When discharge to a karst feature or other direct groundwater connection can not be avoided, the dewatering system must be designed and operated to maintain compliance with the groundwater quality standards contained in applicable regulations, including ch. NR 140 Wis. Adm. Code.
8. If the discharge directly or indirectly enters a stream, the discharge flow rate shall not exceed 50 percent of the peak flow rate of the 2-year 24-hour storm event.

### C. Geotextile Bags

1. Geotextile bags shall meet the criteria listed in Table 1.

**Table 1: Properties for Geotextile Bags**

Property	Test Method	Type I Value	Type II Value
Maximum Apparent Opening Sizes	ASTM D-4751	0.212 mm	0.212 mm
Grab Tensile Strength	ASTM D-4632	200 lbs.	300 lbs.
Mullen Burst	ASTM D-3786	350 psi	580 psi
Permeability	ASTM D-4491	0.28 cm/sec	0.2 cm/sec
Fabric	Nominal Representative Weight	8 oz	12 oz

2. Geotextile bags shall be sized according to the particle size being trapped, expected flow or pumping rate (gallons per minute) per square foot of fabric and a 50% clogging factor. The footprint of the bag shall be no smaller than 100 square feet.
3. Geotextile bags shall be securely attached to the discharge pipe.
4. Polymers can be used to enhance the efficiency of geotextile bags. If polymer is used, the polymer shall be approved by the WDNR and meet the criteria stipulated in WDNR Conservation Practice Standard 1051, Sediment Control Water Application of Polymers. The polymer supplier or applicator shall provide certifications showing that products have met the performance requirements of Standard 1051. If the manufacturer has not completed the required testing, the project may be used to gain that certification provided it meets the site requirements of Standard 1051. Any such testing will be monitored by DNR or WisDOT, with testing done by a qualified third party.

### D. Gravity Based Settling Systems

Gravity based systems rely on settling of particles as the primary means of treatment. To effectively accomplish this, quiescent conditions should exist with sufficient detention time. Practices include portable sediment tanks, sediment traps, sediment basins and wet detention basins.

If polymer is used to enhance settling, the polymer shall be approved by the WDNR and meet the criteria stipulated in WDNR Conservation Practice Standard 1051, Sediment Control Water Application of Polymers. The polymer supplier or applicator shall provide certifications showing that products have met the performance requirements of Standard 1051. If the manufac-

turer has not completed the required testing, the project may be used to gain that certification provided it meets the site requirements of Standard 1051. Any such testing will be monitored by DNR or WisDOT, with testing done by a qualified third party.

1. **Portable Sediment Tank:** These tanks are intended to settle only sands, loamy sands, and sandy loams. If polymer is added, these tanks will also be appropriate for settling loams, silt loams and silts. Portable sediment tanks shall have a minimum of two baffled compartments, and be a minimum of three feet deep. The inlet and outlet pipe shall be a minimum diameter of three inches. Use one of the following methods to size a tank:
  - a. **Settling:** Account for settling of the suspended sediments with the following equation:
 
$$S_a = 1.83 * Q;$$
 where
 
$$S_a = \text{Tank surface area (sq ft)}$$

$$Q = \text{Pumping rate (gallons per minute)}$$

**Note:** 1.83 is a factor that includes the conversion from gpm to cfs (1 gpm = 0.0022 cfs) and the particle settling velocity for Soil Class 1 (0.0012 ft/sec) from WDNR Conservation Practice Standard 1064 Sediment Basin.
  - b. **Filtration:** Build the first chamber as large as possible to aid in settling. Flow capacity shall be determined by the end area of the filter media (fabric) and the flow rate (gallons per minute) per square foot of the finest filter media and a 50% clogging factor.
2. **Sediment Trap or Sediment Basin:** This device is a temporary sediment control device. The design, installation, and operation of the sediment trap or basin shall meet the requirements stipulated in WDNR Conservation Practice Standard 1063 Sediment Trap or Standard 1064 Sediment Basin.
3. **Wet Detention Basin:** This device is generally a permanent structure designed to address post-construction pollutant reduction requirements. The design, installation, and operation of the wet detention basin shall meet the requirements stipulated in WDNR Conservation Practice Standard 1001 Wet Detention Basin.

#### E. Passive Filtration Systems

Passive filtration systems rely on filtration as the primary method of removing particles. Sediment removal efficiency will be related to the particle size distribution in the stormwater. Practices include manufactured filters, filter tanks, filter basins, vegetative filters, grass swales, and filtration fabric.

Filter fabric sediment removal efficiency shall be based on the properties specified in Table 1.

1. **Manufactured Filters:** Filters shall be sequenced from the largest to the smallest pore opening. Sand media filters are available with automatic backwashing features that can filter to 50  $\mu\text{m}$  particle size. Screen or bag filters can filter down to 5  $\mu\text{m}$ . Fiber wound filters can remove particles down to 0.5  $\mu\text{m}$ .
2. **Filter Tank (portable):** Install, operate and maintain according to manufacturer recommendations.
3. **Filter Basin:** Install, operate and maintain according to Wisconsin Department of Transportation technical guidance.
4. **Vegetative Filter:** Refer to WDNR Conservation Practice Standard 1054 Vegetated Buffer for Construction Sites.

#### F. Pressurize Filtration Systems

Pressurized filtration systems differ from passive systems in that the water flowing through the media is pressurized and the filter media is designed to handle higher flow rates. Practices include portable sand filters, wound cartridge units, membranes and micro-filtration units.

Pressurized filters typically have automatic backwash systems that are triggered by a pre-set pressure drop across the filter. If the backwash water volume is small or substantially more turbid than the stormwater stored in the holding pond or tank, returning backwash water to the pond or tank may be appropriate. However, land application or another means of treatment and disposal may be necessary.

Screen, bag, and fiber filters must be cleaned and/or replaced when they become clogged.

1. **Portable Sand Filter:** Install, operate and maintain according to manufacturer recommendations.
2. **Wound Cartridge Units:** Secondary filtration of sediments using high efficiency filter cartridges may be necessary to remove fine particles such as clays. Install, operate and maintain according to manufacturer recommendations.
3. **Membranes and Micro-filtration:** Install, operate and maintain according to manufacturer recommendations.

4. If polymer is used to enhance settling, the polymer shall be approved by the WDNR and meet the criteria stipulated in WDNR Conservation Practice Standard 1051, Sediment Control Water Application of Polymers. The polymer supplier or applicator shall provide certifications showing that products have met the performance requirements of Standard 1051. If the manufacturer has not completed the required testing, the project may be used to gain that certification provided it meets the site requirements of Standard 1051. Any such testing will be monitored by DNR or WisDOT, with testing done by a qualified third party.

## VI. Considerations

- A. It may be necessary to clean the municipal storm drainage system prior to and after discharging to the system to prevent scouring solids from the drainage system.
- B. Geotextile bags are generally not appropriate when discharging to ORW, ERW, waterbodies supporting cold water communities, trout streams, or to *highly susceptible* and *less susceptible wetlands*.
- C. Pressurized filtration systems are the most efficient for removing fine sediments.
- D. Portable sediment tanks may be appropriate when other sediment trapping practices cannot be installed due to lack of space or other reasons.
- E. Filtration is not an efficient treatment of water with heavy sediment loads. Use a settling tank or sand filter as pretreatment when possible.
- F. It may be necessary to use a combination of dewatering practices to achieve the intended results.

## VII. Plans and Specifications

All plans, standard detail drawings, or specifications shall include the schedule for installation, inspection, and maintenance and shall be kept on-site with the erosion control plan.

## VIII. Operation and Maintenance

- A. Sediment shall be removed from devices to maintain effectiveness. All sediment collected in dewatering devices shall be properly disposed of to prevent discharge to waters of the state.
- B. The following monitoring shall be conducted. Test results shall be recorded on a daily log kept on site:
  1. Discharge duration and specified pumping rate
  2. Observed water table at time of dewatering
  3. If used, type and amount of chemical used for pH adjustment
  4. If used, type and amount of polymer used for treatment
  5. Maintenance activities

## IX. References

The American Association of State Highway Officials (AASHTO) Soil Classification System

## X. Definitions

*Exceptional Resource Waters (ERW)* (V.B.1): are waters listed in s. [NR 102.11](#).

*Highly susceptible wetland* (VI.B): include the following types: fens, sedge meadows, bogs, low prairies, conifer swamps, shrub swamps, other forested wetlands, fresh wet meadows, shallow marshes, deep marshes and seasonally flooded basins.

*Karst feature* (III): are an area or geologic feature subject to bedrock dissolution so that it is likely to provide a conduit to groundwater, and may include caves, enlarged fractures, mine features, exposed bedrock surfaces, sinkholes, springs, seeps or swallets.

*Less susceptible wetland* (VI.B): include degraded wetlands dominated by invasive species such as reed canary grass.

*Outstanding Resource Waters (ORW)* (V.B.1): are waters listed in s. [NR 102.10](#).

*Targeted performance standard* (IV): means a performance standard that will apply in a specific area, where additional practices beyond those contained in NR 151 are necessary to meet water quality standards.

*Treatment facility* (V.B.3): includes wastewater treatment plants or wet detention basins constructed in accordance with WDNR Conservation Practice Standard 1001 Wet Detention Basin or other approved land application sites.

Figure 1: USDA Soil Textural Triangle

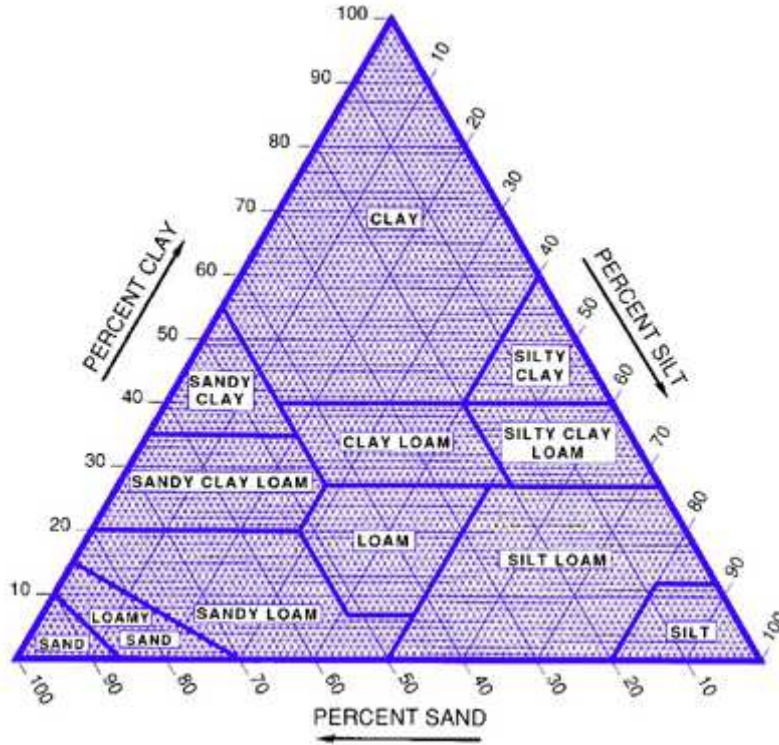



**Figure 3: Factors Influencing The Selection of Dewatering Practices**

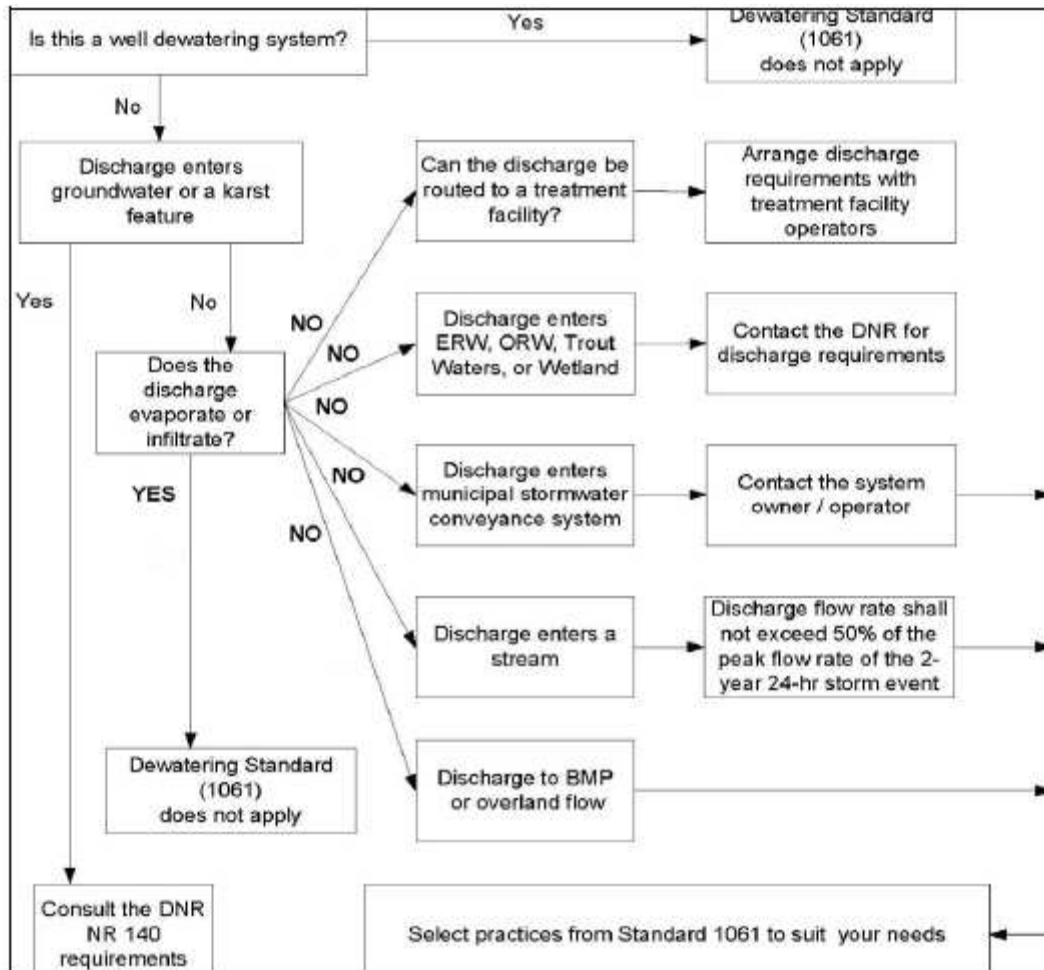

If the dewatering effluent is discolored, has an odor, an oily sheen, or other toxins are present notify the DNR immediately  
**24 Hours Spills Reporting Hotline 1-800-943-0003**

Conservation Practice Standards are reviewed periodically and updated if needed. To obtain the current version of this standard, contact your local WDNR office or the Standards Oversight Council office in Madison, WI.

WDNR, WI  
4/07

<sup>1</sup> Words in the standard that are shown in italics are described in X. Definitions. The words are italicized the first time they are used in the text.

**Ditch Check****(Channel)****1062 (3/06)**

Wisconsin Department of Natural Resources

Conservation Practice Standard

**Note:** Words in the standard that are shown in italics are described in X. Definitions. The words are italicized the first time they are used.

**I. Definition**

A temporary dam constructed across a swale or drainage ditch to reduce the velocity of water flowing in the channel. *Ditch checks*<sup>1</sup> can be constructed out of stone, a double row of straw bales or from engineered products found on the Wisconsin Department of Transportation (WisDOT) Erosion Control Product Acceptability List (PAL).

**II. Purpose**

The purpose of this practice is to reduce flow velocity and to pond water, thereby reducing active channel erosion and promoting settling of suspended solids behind the ditch check.

**III. Conditions Where Practice Applies**

This Standard applies where grading activity occurs in areas of channelized flows and a temporary measure is needed to control erosion of the channel until permanent stabilization practices can be applied.

Under no circumstance shall ditch checks be placed in intermittent or perennial stream without permission from WDNR. This Practice may not be substituted for major perimeter trapping measures.

**IV. Federal, State, and Local Laws**

Users of this standard shall be aware of applicable federal, state, and local laws, rules, regulations, or permit requirements governing the use and placement of ditch checks. This standard does not contain the text of federal, state, or local laws.

**V. Criteria**

This section establishes the minimum standards for design, installation and performance requirements.

**A. Height**

1. Installed, the minimum height of ditch checks shall be 10 inches and shall not exceed a maximum height of 16 inches for manufactured or biodegradable materials and 36 inches for stone (or other inorganic materials).
2. Ditch checks must be installed with the center lower than the sides forming a weir. If this is not done stormwater flows are forced to the edge of the ditch check thus promoting scour, or out of the channel causing excessive erosion.
3. Stone ditch checks shall have a minimum top width of 2-feet measured in the direction of flow with maximum slopes of 2:1 (2 horizontal to 1 vertical) on the upslope side and 2:1 on the down slope side.

**B. Placement**

1. At a minimum install one ditch check for every two feet of drop in the channel.
2. Ditch checks shall be placed such that the resultant ponding will not cause inconvenience or damage to adjacent areas.

**C. Material Specifications**

1. Stone ditch checks shall be constructed of a well-graded angular stone, a  $D_{50}$  of 3 inch or greater, sometimes referred to as breaker run or shot rock.
2. Ditch checks may be constructed of other approved materials but must be capable of withstanding the flow velocities in the channel. Manufactured products listed in WisDOT's PAL are also acceptable for temporary ditch checks.

**Note:** Silt fence and single rows of straw bales are ineffective as ditch checks and are not permitted.

- D. Construction – Refer to Figure 1 & 2
1. Ditch checks shall be utilized during rough grading and shall be removed once the final grading and channel stabilization is applied, unless intended to be part of a permanent stormwater management plan.
  2. Channel erosion mat or other non-erodible materials shall be placed at the base of a ditch check, and extended a minimum of 6 feet, to prevent scour and washing out the toe of the ditch check. DNR Conservation Practice Channel Erosion Mat (1053) contains criteria for the placement of erosion mat in this location.
  3. Chink or seal stone and rock ditch checks to minimize the flow through the ditch check.

## VI. Considerations

- A. For added stability, the base of a stone or rock ditch check should be keyed into the soil to a depth of 6-inches.
- B. Stone ditch checks may be underlain by a nonwoven geotextile fabric to ease installation and removal. If the geotextile fabric is extended, it can serve purpose specified in section V.D.2
- C. Ditch checks installed in grass lined channels may kill the vegetation if water is ponded for extended periods or excessive siltation occurs. Proper maintenance is required to keep areas above and below the ditch check stabilized.
- D. The best way to prevent sediment from entering the storm sewer system is to stabilize the disturbed area of the site as quickly as possible, preventing erosion and stopping sediment transport at its source.
- E. When placing ditch checks in swales adjacent to roadways consider designating a ‘clear zone’ free of obstacles posing a threat to out of control vehicles.
- F. Mowing operations may throw stones from ditch checks causing a potential safety hazard.

## VII. Plans and Specifications

- A. Plans and specifications for installing ditch checks shall be in keeping with this standard and shall describe the requirements for applying the practice to achieve its intended purpose. The plans and specifications shall address the following:
  1. Location and spacing of ditch check
  2. Schedules and sequence of installation and removal
  3. Standard drawings and installation details
  4. Rock gradation
- B. All plans, standard detail drawings, or specifications shall include schedule for installation, inspection, and maintenance. The responsible party shall be identified.

## VIII. Operation and Maintenance

- A. Ditch checks shall, at a minimum, be inspected weekly and within 24 hours after every precipitation event that produces 0.5 inches of rain or more during a 24 hour period.
- B. Unless incorporated into a permanent stormwater management system, ditch checks shall be removed once the final grading and channel stabilization is applied.
- C. Sediment deposits shall be removed when deposits reach 0.5 the height of the barrier. Removal of sediment may require replacement of stone. Maintenance shall be completed as soon as possible with consideration to site conditions.

## IX. References

WisDOT “Erosion Control Product Acceptability List” is available online at: <http://www.dot.wisconsin.gov/business/engrserv/pal.htm>. Printed copies are no longer distributed.

## X. Definitions

*D*<sub>50</sub> (V.C.1): The particle size for which 50% of the material by weight is smaller than that size.

*Ditch Checks* (I) Are commonly referred to as temporary check dams. Stone ditch checks refer to those made out of either stone or rock.

Figure 1

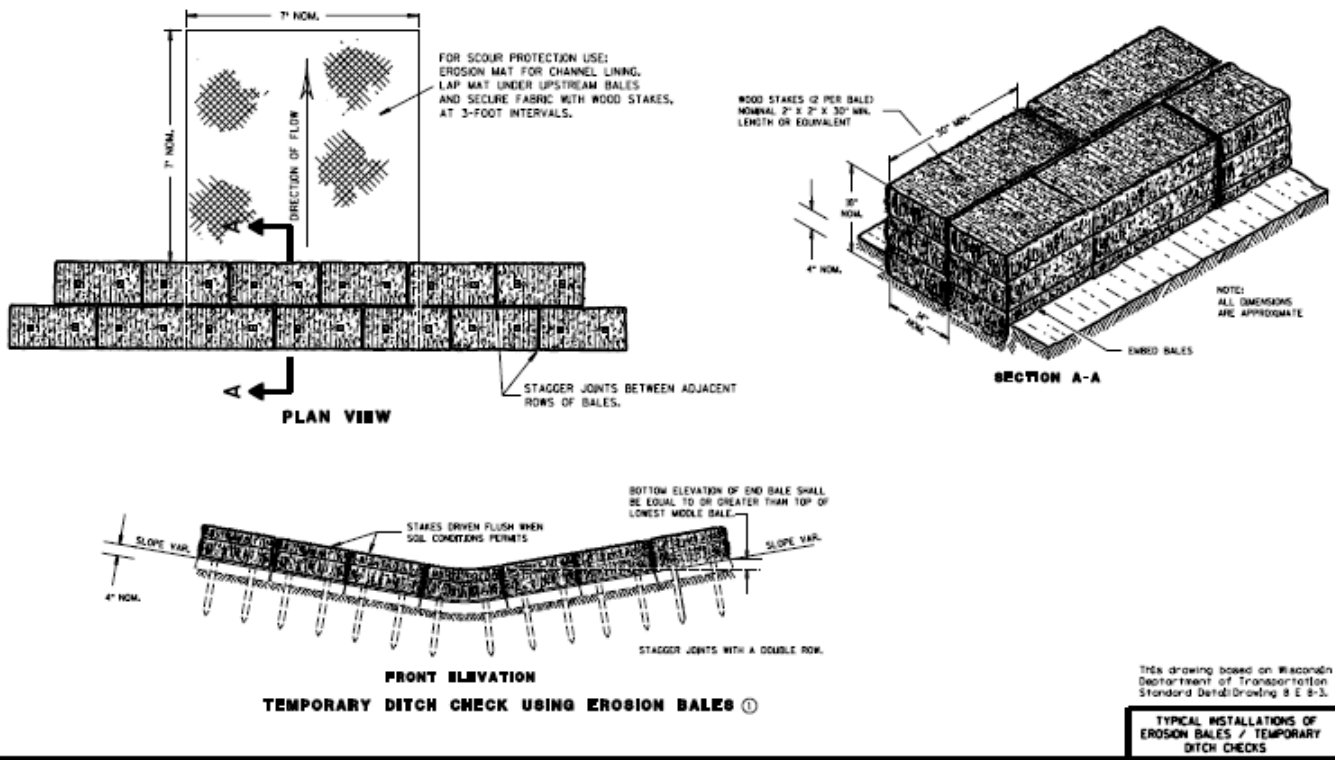
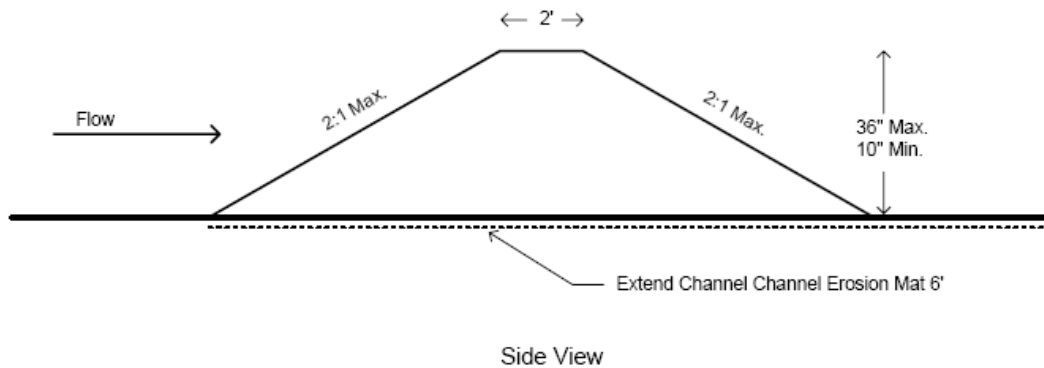

Figure 2. Stone Ditch Check



## Construction Site Diversion

1066 (03/06)

Wisconsin Department of Natural Resources  
Conservation Practice Standard

**Note:** Words in the standard that are shown in italics are described in IX. Definitions. The words are italicized the first time they are used.

### I. Definition

A *temporary*<sup>1</sup> berm or channel constructed across a slope to collect and divert runoff.

### II. Purpose

To intercept, divert, and safely convey runoff at construction sites in order to divert clean water away from disturbed areas, or redirect sediment laden waters to an appropriate sediment control facility.

### III. Conditions Where Practice Applies

- A. This practice is applicable to construction sites where temporary surface water runoff control or management is needed. Locations and conditions include:
  1. Above disturbed areas, to limit runoff onto the site.
  2. Across slopes to reduce slope length.
  3. Below slopes to divert excess runoff to stabilized outlets.
  4. To divert sediment-laden water to sediment control facilities.
  5. At or near the perimeter of the construction area to keep sediment from leaving the site.
- B. This standard does not pertain to permanent diversions. Refer to appropriate design criteria and local regulations when designing permanent diversions.

### IV. Federal, State, and Local Laws

Users of this standard shall be aware of applicable federal, state, and local laws, rules, regulations, or permit requirements governing the use and placement of this practice. This standard does not contain the text of federal, state, or local laws.

### V. Criteria

- A. The diversion shall have stable side slopes and shall not be overtopped during a 2-year frequency, 24-hour duration storm. The minimum berm cross section shall be as follows:
  1. Side slopes of 2:1 (horizontal:vertical) or flatter.
  2. Top width of two feet.
  3. Berm height of 1.5 feet.
- B. Sediment-laden runoff from disturbed areas shall be diverted into a sediment control practice. For typical sediment control practices see WDNR Conservation Practice Standards Sediment Trap (1063) or Sediment Basin (1065) for design criteria.
- C. When diverting clean water the diversion channel and its outfall shall be immediately *stabilized* for the 2-year frequency, 24-hour duration storm. Build and stabilize clean water diversions before initiating down slope land-disturbing activities.
- D. Diversions shall be protected from damage by construction activities. At all points where diversion berms or channels will be crossed by construction equipment, the diversion shall be stabilized or shaped appropriately. Temporary culverts of adequate capacity may be used.
- E. For diversions that are to serve longer than 30 days, the side slopes including the ridge, and down slope side the diversion shall be stabilized as soon as they are constructed. The diversion channel should be stabilized (i.e. erosion mat) or a larger sediment control practice shall be needed. For diversions serving less than 30 days, the down slope side of the diversion shall be stabilized as soon as constructed.

**VI. Considerations**

- A. The channel cross section may be parabolic, v-shaped or trapezoidal. The use of “V” channels is generally discouraged due to potential erosion problems.
- B. Ditch checks may be used to enhance sediment removal. Ditch checks shall be designed in accordance with WDNR Conservation Practice Standard Ditch Check (1062).
- C. For diversion berms consider designing an emergency overflow section or bypass area to limit damage from storms that exceed the 2-year frequency 24-hour duration storm. The overflow section may be designed as a stabilized weir with riprap protection.

**VII. Plans and Specifications**

- A. Plans and specifications for installing diversions shall be in keeping with this standard and shall describe the requirements for applying the practice to achieve its intended purpose. The plans and specifications shall address the following:
  - 1. Diversion location.
  - 2. Channel grade or elevations.
  - 3. Typical cross section.
  - 4. Channel stabilization if required.
- B. All plans, standard detail drawings, or specifications shall include schedule for installation, inspection, and maintenance. The responsible party shall be identified.

**VIII. Operation and Maintenance**

- A. Diversions shall, at a minimum, be inspected weekly and within 24 hours after every precipitation event that produces 0.5 inches of rain or more during a 24-hour period.
- B. Maintenance shall be completed as soon as possible with consideration to site conditions.
- C. Accumulated sediment shall be removed when it reaches one half the height of the diversion berm. Properly dispose of any sediment removed from the diversion.
- D. Diversions shall be removed and the area stabilized according to construction plans.

**IX. Definitions**

*Temporary (I)*: an erosion control measure that is utilized during construction and grading operations prior to final stabilization.

*Stabilized (V.C)*: means protecting exposed soil from erosion.

## **Dust Control On Construction Sites**

**1068 (03/04)**

Wisconsin Department of Natural Resources  
Conservation Practice Standard

### **I. Definition**

Dust control includes practices used to reduce or prevent the surface and air transport of dust during construction.

Dust control measures for construction activities include minimization of soil disturbance, applying mulch and establishing vegetation, water spraying, surface roughening, applying polymers, spray-on tackifiers, chlorides, and barriers.

### **II. Purpose**

This practice may be used to:

- Reduce wind erosion and dust.
- Minimize deposition of dust and wind transported soils into water bodies through runoff or wind action.
- Reduce respiratory problems.
- Minimize low visibility conditions caused by airborne dust.

### **III. Conditions Where Practice Applies**

Dust control measures may be applied at any construction site, but is particularly important for sites with dry exposed soils which may be exposed to wind or vehicular traffic.

### **IV. Federal, State, and Local Laws**

Users of this standard shall comply with applicable federal, state and local laws, rules, regulations or permit requirements governing this practice. This standard does not contain the text of federal, state, or local laws.

### **V. Criteria**

This section establishes the minimum standards for design, installation and performance requirements.

- A. The implementation of dust control shall limit the area exposed for dust generation.
- B. Asphalt and petroleum based products cannot be used for dust control.
- C. Mulch and Vegetation – Mulch or seed and mulch may be applied to protect exposed soil from both wind and water erosion.

Refer to WDNR Conservation Practice Standards Mulching for Construction Sites (1058) and Seeding for Construction Site Erosion Control (1059) for criteria.

- D. Water – Water until the surface is wet and repeat as needed. Water shall be applied at rates so that runoff does not occur.

Treated soil surfaces that receive vehicle traffic require a stone tracking pad or tire washing at all point of access. Refer to WDNR Conservation Practice Standard Stone Tracking Pad and Tire Washing (1057) for criteria.

- E. Tillage – A control measure performed with chisel type plows on exposed soils. Tillage shall begin on the windward side of the site. Tillage is only applicable to flat areas.
- F. Polymers – Polymers can be an effective practice for areas that do not receive vehicle traffic. Dry applied polymers must be initially watered for activation to be effective for dust control. Refer to WDNR Conservation Practice Standard Erosion Control Land Application of Polymers (1050) for application criteria.
- G. Tackifiers and Soil Stabilizers Type A – Products must be selected from and installed at rates conforming to the WisDOT Erosion Control PAL. See Section IX for reference. Example products include Latex-based and WDNR, WI

## Temporary Grading Practices For Erosion Control (Surface Roughening and Temporary Ditch Sumps)

**1067 (03/04)**

Wisconsin Department of Natural Resources

Conservation Practice Standard

**Note:** Words in the standard that are shown in italics are described in X. Definitions. The words are italicized the first time they are used.

### **I. Definition**

Temporary<sup>1</sup> grading practices used to minimize construction site erosion. These practices include, but are not limited to surface roughening (directional tracking and tillage) and temporary ditch sumps.

### **II. Purpose**

The purpose of these practices are to minimize erosion and sediment transport during grading operations on construction sites.

### **III. Conditions Where Practice Applies**

These practices apply where land disturbing activities occur on construction sites. These practices shall be used in conjunction with other erosion control practices.

### **IV. Federal, State, and Local Laws**

Users of this standard shall be aware of applicable federal, state, and local laws, rules, regulations, or permit requirements governing these practices. This standard does not contain the text of federal, state, or local laws.

### **V. Criteria**

These interim practices may be employed in addition to the approved grading plan to reduce erosion and sediment transport.

- A. **Surface Roughening** – Surface roughening is abrading the soil surface with horizontal ridges and depressions across the slope to reduce runoff velocities.
  - 1. **Directional Tracking** – The process of creating ridges with tracked vehicles on unvegetated slopes. This method is used for short durations on sites actively being grad and shall be used in conjunction with other practices. This practice shall be in place at the end of each workday.
 

Directional tracking involves driving a tracked vehicle up and down a slope. The tracks create horizontal grooves and ridges. The rough surface slows sheet runoff and helps to prevent rills from forming. (Conversely, if the tracked vehicle is driven along the contour the tracks create vertical grooves and ridges for the water to follow, increasing erosion.)
  - 2. **Tillage** – Utilizing conventional tillage equipment to create a series of ridges and furrows on the contour no more than 15 inches apart.
- B. **Temporary Ditch Sump** – Temporary ditch sumps are ½ to 5 cubic yard excavations made in a drainageway during earthmoving operations. Their purpose is to slow and pond runoff during the time that drainageways are being graded. Sumps shall be in place prior to anticipated rain events.

Construction involves excavating sumps (holes) in the rough ditch grade, and using the excavated material to form a dike on the downstream side of the sump.

Temporary ditch sumps are not effective perimeter controls. Other sediment control practices shall be utilized prior to channels discharging into public waterways.

## **VI. Considerations**

- A. Directional tracking may compact the soil, therefore additional seedbed preparation may be required. Refer to WDNR Conservation Practice Standard Seeding for Construction Site Erosion Control (1059) for seedbed preparation and seeding criteria.
- B. When constructing a temporary ditch sump, compacting the dike provides additional stability.
- C. Consider at a minimum excavating ½ cubic yard per 1% gradient, for every 500 feet of channel when constructing temporary ditch sumps.

## **VII. Plans and Specifications**

Due to the interim nature of these practices, and the fact that location determinations are made in the field, they need only be referenced in the erosion control plan narration or general notes.

## **VIII. Operation and Maintenance**

These practices shall be inspected and repaired or reinstalled after every runoff event.

## **IX. References**

Virginia Department of Conservation and Recreation. 1992. Virginia Erosion and Sediment Control Handbook, Third Edition. Chapter 3 – 3.29 Surface Roughening.

Dane County. 2002. Dane County Erosion Control and Stormwater Manual, First Edition. Appendix Surface Roughening S-16.1.

## **X. Definitions**

Temporary (I): An erosion control measure that is utilized during construction site grading activities.

**Interim Sediment Control**  
**Water Application of Polymers**  
**1051 (11/02)**

Wisconsin Department of Natural Resources  
 Conservation Practice Standard

**Note:** Words in the standard that are shown in italics are described in IX. Definitions. The words are italicized the first time they are used.

**I. Definition**

The application of products containing *polymers*<sup>1</sup> to *sediment control structures*.

**II. Purpose**

The purpose of this practice is to settle out or remove suspended *sediment* from water within sediment control structures.

**III. Conditions Where Practice Applies**

This practice shall be used with self-contained sediment control structures, on a temporary basis for construction sites, in an emergency for post-construction sites and only continually at sites holding an individual permit, if needed to improve the sediment removal efficiency of the structure. Polymers shall not be directly applied to *surface waters of the state*. Sediment control structures may be within, or discharge to, surface waters of the state.

**IV. Federal, State and Local Laws**

Water applications of polymer shall comply with all federal, state, and local laws, rules or regulations governing polymers. The operator is responsible for securing required permits. This standard does not contain the text of the federal, state, or local laws governing polymers.

**V. Criteria**

A. Toxicity Criteria

If used in accordance with the use restriction, the polymer mixture shall meet an acceptable level of risk such that the product can be used without significant harm to organisms that inhabit or come in contact with the aquatic environment. Every attempt shall be made to eliminate the use of any chemicals known to be environmentally toxic within a polymer mixture. Polymer mixtures shall be non-combustible.

The manufacturer shall supply toxicity testing data to the Wisconsin Department of Natural Resources (WDNR) based on the polymer mixture, including any binding or buffering agents, catalyst or any other additives.

1. The use of cationic *polyacrylamide* shall be avoided where there is danger of impacting aquatic organisms because its toxicity to aquatic test species occurs at very low concentrations.
2. Anionic polymer mixtures shall have  $\leq .05\%$  free acrylamide monomer by weight as established by the Food and Drug Administration (FDA) and the Environmental Protection Agency (EPA).
3. Each manufacturer shall provide to the WDNR toxicity information (including acute and chronic water column toxicity test data) from a certified lab, as defined in ch. NR 149 Wis.Adm.Code, for the polymer mixture.

This data shall include all raw and statistical data regarding death, sub-lethal observations such as immobility, and any other test observations. *Standardized toxicity testing* procedures should be used and referenced. A *use restriction* will be calculated by WDNR using the information in Appendix I.

4. Users of polymer mixtures shall obtain and follow all *Material Safety Data Sheet (MSDS)* requirements, manufacturer's recommendations, and WDNR use restrictions.

B. Application Criteria

1. Maximum application rates, per storm event, in pounds per acre-feet shall be the lesser of WDNR's use restriction multiplied by 1.35 or the manufacturer's recommended application rate (1.35 is a conversion factor that is used to change the use restriction from ppm to an application rate in pounds per acre-feet).

2. Neither the manufacturer's written application rate recommendations, nor the application rate shall exceed the WDNR use restriction. The manufacturer or distributor shall provide for the applicator:
  - a. Labels affixed to the polymer mixture containers that indicate the recommended application rate and the maximum application rate based on the use restriction.
  - b. A product expiration date for the polymer mixture based on product expiration dates of the polymer.
  - c. General written application methods.
  - d. Written instructions to provide proper safety, storage, and mixing of their product.
3. The application method shall provide for uniform distribution of the product in the sediment control structure and shall consist of either:
  - a. Passive Applications: Polymers applied by non-mechanically dosing the sediment-laden inflow prior to it entering the impoundment area of the sediment control structure. The manufacturer shall base passive application rates on the dissolution rate and/or the dead storage volume of the sediment control structure.

or

  - b. Active or Mechanical Applications: Polymer applied by mechanically or hydraulically mixing directly into a sediment control structure.
4. The applicator of the polymer mixture shall at the time of application, document the following:
  - Name of applicator
  - Application rate in pounds per acre-feet of stormwater runoff
  - Date applied
  - Product type
  - Weather conditions during application
  - Method of application

Copies of this documentation shall be entered into the contractor's monitoring log or a project diary and made available upon request.

#### C. Product Approval Criteria

The manufacturer shall certify, through independent sampling and test results, that their product performs as per the following requirements. (The product approval process is depicted in flow chart form in Figure 1.)

1. The toxicity information required in section V.A.3. of this standard shall be reviewed by the WDNR and used to generate a written product use restriction for the polymer mixture. Appendix I outlines the information that needs to be submitted as a part of this review, and states where they must be submitted.
2. Polymer mixtures shall achieve = 95% sediment reduction as measured by the standpipe method outlined in Appendix II.
3. Performance criteria – active and passive applications shall be field tested and submitted separately:
  - a. The performance of polymer mixtures shall be verified and field-tested in a body of water that is not discharging directly into the waters of the state. The body of water shall be a minimum of 1/3-acre surface area and an average depth of at least 3 feet.
  - b. The total suspended solids prior to the polymer treatment must be tested and verified by an independent testing lab, and must have a minimum value of 800 ppm or equivalent *Nephelometric Turbidity Units (NTU)* and be visibly turbid. The relationship between total suspended solids (TSS) and NTU is site-specific and the derivation of a unique TSS-NTU relationship shall be conducted for each sediment control structure. A minimum of two samples per acre-foot of water shall be taken from random locations within the test site.
  - c. Within 48 hours from the initial treatment of the water body, the total suspended solids must have a maximum of 80 ppm, or equivalent NTU.
  - d. Testing sites may not be used for subsequent testing for a period of 3 months from the time of initial application.
  - e. The Wisconsin Department of Transportation (WisDOT) shall be notified at least 7 days prior to testing, and WisDOT and/or WDNR staff shall be allowed to monitor any such testing.

4. The WisDOT Erosion Control Storm Water/Product Acceptability List Committee will review and approve products as per the process set forth in WisDOT's Product Acceptability List (PAL).
5. The polymer mixture must be resubmitted if any portion of the mixture is altered subsequent to its approval. Such alterations may include:
  - a. The amendment of base polymers and/or any other additives
  - b. The ratios of individual components

## VI. Considerations

The following are additional recommendations, which may enhance the use of, or avoid problems with, the practice.

- A. When using products in impoundments immediately adjacent to, or within waters of the state, consider using products for which the manufacturer's recommended application rate is considerably lower than the use restriction.
- B. The applicator should use the least amount of polymer mixture to achieve optimal performance.
- C. Polymer mixtures should be applied in conjunction with other erosion control BMPs and under an erosion and sediment control or stormwater management plan.
- D. Test the pH of the water in the sediment control structure and follow the manufacturer's recommended pH range for their polymer mixture, as pH will impact the effectiveness of polymer mixtures.
- E. Ethylene glycol, propylene glycol or any other known environmental toxicants should not be included in the polymer mixture.
- F. Care must be taken to prevent spills of polymer mixtures. Follow the manufacturer's recommended cleanup procedures in the event of a spill.
- G. Inhaling granular polymer may cause choking or difficulty breathing. Persons handling and mixing polymer should use personal protective equipment of a type recommended by the manufacturer.
- H. Polymer mixtures combined with water are very slippery and can pose a safety hazard.
- I. Polymer mixtures should be considered as an aid to removing solids from dredge slurries.
- J. Where polymer mixtures are used with sediment control structures in the stream, such as during bridge construction, the structure should not be removed until the water is clarified. If the resulting sediment floc is more than a half a foot deep it should be excavated or filtered out.

## VII. Specifications

Erosion and sediment control and stormwater management plans specifying polymer mixtures for sediment control shall be in keeping with this standard and shall describe the requirements for applying the practice to achieve its intended purpose.

## VIII. Operation and Maintenance

Sediment levels on the bottom of the sediment control structure shall be monitored to measure the loss of storage capacity over time due to enhanced sedimentation by the polymer mixture.

## IX. Definitions

*Material Safety Data Sheets (MSDS)* (V.A.3) Provide basic information on a material or chemical product intended to help someone work safely with the material. This includes a brief synopsis of the hazards associated with using a material, how to use it safely, and what to do if there is an emergency. The retail distributor and/or manufacturer as per OSHA's Hazard Communication Standard, 29 CFR 1910.1200, must provide MSDS, with the purchase of potentially hazardous products.

*Nephelometric Turbidity Units (NTU)* (V.C.3.b) A measure of the amount of light scattered by suspended and dissolved materials in the sample.

*Polyacrylamide* (V.A.1) A generic term for polymers made up of many repeating units of the monomer acrylamide (a simple organic compound).

*Polymer* (I) Polymers are materials that are either natural or synthetic and that have a chain of carbon molecules that are identical, repeating units. Polymers can be positively charged (cationic), negatively charged (anionic) or have no charge (non-ionic).

*Polymer Mixture* (V.A) Any reference to polymer mixtures refers to the whole manufactured product, including the polymer and any additives. Additional calcium or lime may be added as a buffering agent without being considered part of the whole manufactured product.

*Sediment* (II) refers to settleable soil, rock fragments and other solids suspended in runoff.

*Sediment control structure* (I.) A sediment control structure is an impoundment designed to intercept and detain sediment carried in runoff, prior to the runoff reaching the main channel of a waterway or body of water. Placement of these structures must be outside of the main channel of a waterway and shall not span opposing stream banks in channelized flow. The sediment control structure must provide for dedicated sediment storage to at least a depth of two feet, such that the sediment will not be subject to re-suspension during high velocity flow conditions.

Impoundments may be created by a cofferdam, turbidity barrier, earthen berm, sheet piling, self-contained filtering systems or similar material. Examples include properly maintained construction or post-construction sediment ponds, discharging directly or eventually to a water body. They may also include surface water impoundments that are immediately adjacent to a waterway, whose function is to treat stormwater or dredging material. Another potential application is to isolate localized areas surrounding bridge and culvert construction.

*Standardized toxicity testing* (V.A.2) Examples of such include, but are not limited to, those outlined in the State of Wisconsin Aquatic Life Toxicity Testing Methods Manual (Fleming, et.al, 1996) or Short-term Methods for Estimating the Chronic Toxicity of Effluents and Receiving Water to Freshwater Organisms (Lewis, et.al, 1994). The WDNR use restriction shall be developed from this data.

*Surface Waters of the State* (III) “Surface” refers to the sub portion of the waters of the state that discharge at the surface. Waters of the state, as defined by s. 283.01(20), Wis. Stats means those portions of Lake Michigan and Lake Superior within the boundaries of Wisconsin, all lakes, bays, rivers, streams, springs, ponds, wells, impounding reservoirs, marshes, water courses, drainage systems and other surface water or groundwater, natural or artificial, public or private within the state or under its jurisdiction, except those waters which are entirely confined and retained completely upon the property of the person.

*Use Restriction* (V.A.2) Identifies the concentration below which a product is not expected to cause acute toxicity in the aquatic environment.

## X. References

Voluntary Use Of Polymers In DNR Programs (A Field Guide) For copies of this companion document contact Mary Anne Lowndes, Water Resources Engineer Bureau of Watershed Management 101 S. Webster St., Box 7921, Madison, WI 53707-7921 Phone (608) 261-6420 [MaryAnne.Lowndes@dnr.state.wi.us](mailto:MaryAnne.Lowndes@dnr.state.wi.us)

Fleming, K., P. Hubbard, N. Krause, R. Masnado, D. Piper, W. Repavich, G. Searle, S. Thon, “State of Wisconsin Aquatic Life Toxicity Testing Methods Manual, Edition 1.” Bureau of Watershed Management, Wisconsin Department of Natural Resources, Madison, 1996 (WI. PUBL-WW-033-96).

Lewis, P.A., D.J. Klemm, J.M. Lazorchak, T.J. Norberg-King, W.H. Peltier, and M.A. Heber, “Short-Term Methods for Estimating the Chronic Toxicity of Effluents and Receiving Waters to Freshwater Organisms, 3rd Edition.” Environmental Monitoring Systems Laboratory, U.S. Environmental Protection Agency, Cincinnati, OH, 1994 (EPA/600/4-91/002).

Roa-Espinosa, A., Bubenzer, G.D. and Miyashita, E., “Sediment and Runoff Control on Construction Sites Using Four Application Methods of Polyacrylamide Mix.” National Conference on Tools for Urban Water Resource Management and Protection, Chicago, pp. 278, February 7-10, 2000.

Roa, A., “Are there Safety Concerns or Environmental Concerns with PAM?” Dane County Land Conservation Department, 1997.

Sojka, R.E. and Lentz, R.D., “A PAM Primer: A brief history of PAM and PAM related issues.” Kimberly, ID: USDA-ARS Northwest Irrigation and Soils Research Lab, 1996. <http://kimberly.ars.usda.gov>.

Wirtz, J. R., “The Pros and Cons of the Use of Anionic Polyacrylamides to Control Erosion and Sedimentation in the Lake Mendota Priority Watershed”. University of Wisconsin-Madison, MS Thesis, 2000.

WisDOT’s Product Acceptability List (PAL). State DOT web site: <http://www.dot.wisconsin.gov/business/engrserv/pal.htm>. Questions regarding product approvals may be sent to: New Products Engineer, WisDOT, Technology Advancement, 3502 Kinsman Blvd., Madison, WI 53704.

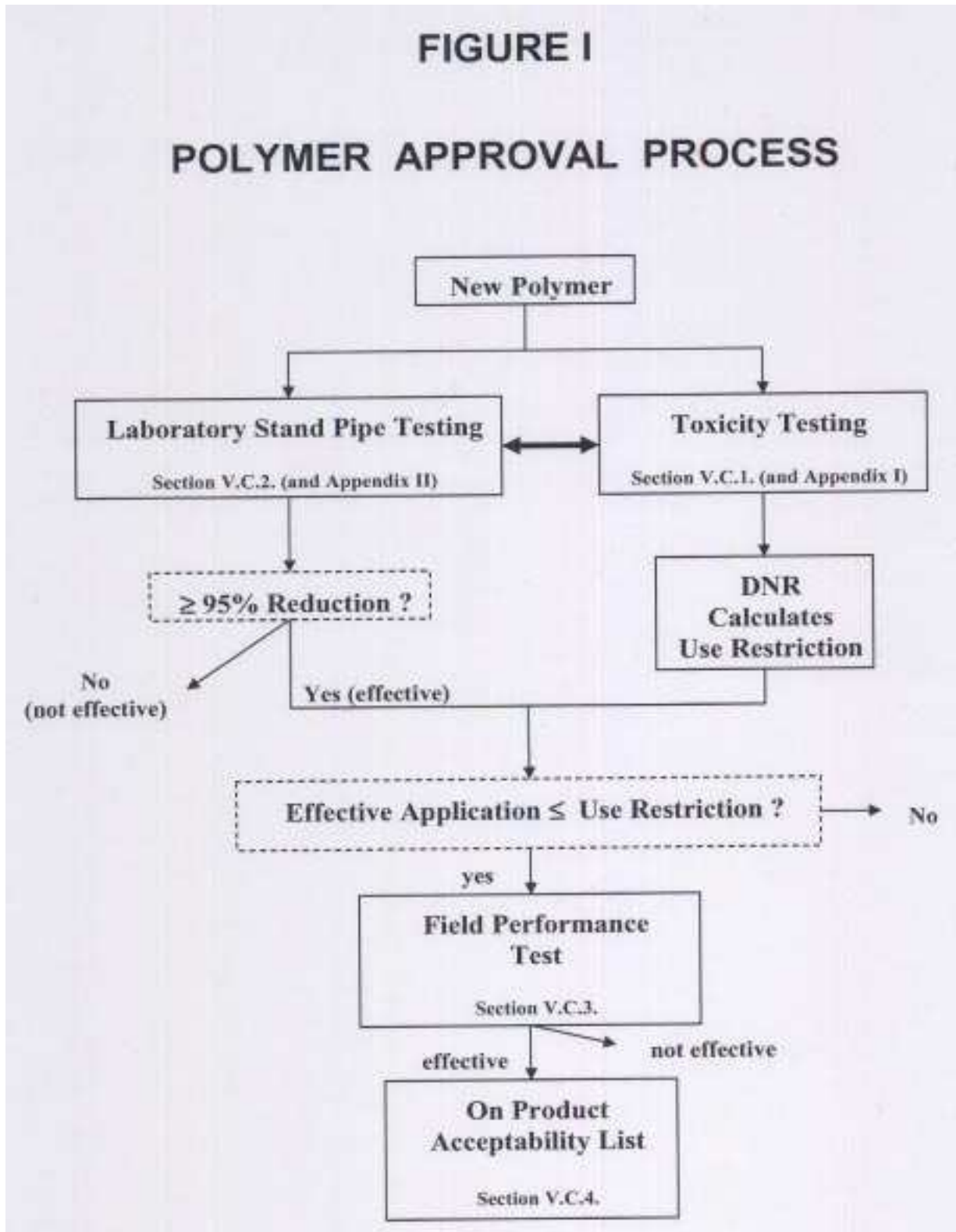

**Interim Sediment Control  
Water Application of Polymers**

**APPENDIX I**

**REQUIRED TOXICITY INFORMATION FOR WDNR REVIEW**

Toxicity information shall be reviewed by the WDNR and will be used to generate a written product use restriction for the polymer. With Chapter 1.7 of the *Whole Effluent Toxicity Program Guidance Document* (Fleming et. al., 2000) as a basis, the following toxicological information/data is required:

- a. Manufacturer of the polymer.
- b. Chemical name of the polymer.
- c. Active Ingredient(s) (if not proprietary information).
- d. Chemical Abstracts Service (CAS) #(s) of the polymer and/or active ingredients.
- e. Material Safety Data Sheet (MSDS) and/or official toxicity test results listing available aquatic life toxicity data for the **WHOLE PRODUCT**. Toxicity data for active ingredients is not acceptable for use in calculating a use restriction. The following types of data is acceptable:

<b>Species</b>	<b>Endpoint of Concern</b>
<i>Ceriodaphnia dubia</i> (Cladoceran)	48-hour LC <sub>50</sub> or EC <sub>50</sub> /IC <sub>25</sub>
<i>Daphnia magna</i> (Cladoceran)	48-hour LC <sub>50</sub> or EC <sub>50</sub> /IC <sub>25</sub>
<i>Lepomis macrochirus</i> (Bluegill Sunfish)	96-hour LC <sub>50</sub> or EC <sub>50</sub> /IC <sub>25</sub>
<i>Pimephales promelas</i> (Fathead Minnow)	96-hour LC <sub>50</sub> or EC <sub>50</sub> /IC <sub>25</sub>
<i>Oncorhynchus mykiss</i> (Rainbow Trout)	96-hour LC <sub>50</sub> or EC <sub>50</sub> /IC <sub>25</sub>

LC<sub>50</sub> = the estimated concentration of polymer that would cause 50% mortality to the test population following the given time period

EC<sub>50</sub> = the estimated concentration of polymer that would cause a given effect in 50% of the test population following a given time period

IC<sub>25</sub> = the estimated concentration of polymer that would cause a 25% reduction in some biological measurement of the test population following a given time period

**Note:** To calculate a use restriction it is necessary to have data from at least one of the cladoceran species and at least one of the fish species (according to s. NR 106.10 (1)).

- a. Complete listing of toxicity test conditions. Examples to follow include Tables 11 – 14 in Weber (1993).
- b. Standardized test methodology (name of a specific method & its reference may be listed for this, such as “Acute Toxicity Test Procedures for *Daphnia magna*” in Weber (1993). If a modification to a standardized method was used, provide the reference of the specific method along with a specific listing of and reasons for the modifications).
- c. Any noted observations from the toxicity tests.

Toxicity test results shall be submitted to: Water Quality Standards Section, WDNR, 101 South Webster Street, P.O. Box 7921, Madison, WI 53707, as one prequalification for field testing.

**References:**

Weber, C. 1993. *Methods for Measuring the Acute Toxicity of Effluents and Receiving Waters to Freshwater and Marine Organisms, 4<sup>th</sup> Edition*. Environmental Monitoring Systems Laboratory, U.S. Environmental Protection Agency, Cincinnati, OH. EPA/600/4-90/027F.

Fleming, K., S. Geis, E. Korthals, R. Masnado, G. Searle. 2000. *Whole Effluent Toxicity Program Guidance Document, Revision #3*. Wisconsin Department of Natural Resources, Chapter 1.7.

## Interim Sediment Control Water Application of Polymers

### APPENDIX II

#### LABORATORY STANDPIPE TEST METHODOLOGY

1. Place 40 grams of oven dried “soil” in 2 liters of distilled water within a 2 liter graduated cylinder with stopper. The 40 grams of “soil” represents a “realistic” runoff suspended solids load of 20,000 mg/L (20,000 mg/L x 2 L) according to data collected from commercial and residential construction sites (Owens, et. al. 2000). Repeat a minimum of four times so that there are a minimum of five replicates. The “soil” used in the standpipe test may be characterized by one of the following three options:

*Clays*                    A clay “soil” is characterized as having greater than 20% of its particles < 2 µm in size. This option is appropriate for those seeking approval\* of a polymer for use in any soil condition (clay, silt, or other).

*Silts*                      A silt “soil” is characterized as having less than 20% of its particles < 2 µm in size AND greater than 20% of its particles 2–25 µm in size. This option is appropriate for those seeking approval\* of a polymer for use only in silt soils. The 2–25 µm size is representative of fine to medium silt soils.

*Site-Specific*        Use of a site-specific “soil” provides an alternative for those seeking approval\* of a polymer that may be customized for optimum performance (in both terms of suspended sediment removal and amount of polymer used) at a particular site. The results of a mechanical soil analysis characterizing the site soil sample particle size composition must be provided. The results of this analysis should be submitted with the results of the standpipe test entered on the “Standpipe Test Data Sheet.” This option is provided since each site will have at least slight differences, if not significant differences, in soil chemical and physical characteristics. These differences may influence the effectiveness of any given polymer.

Indicate which “soil” type is used in the standpipe test on the data sheet under “√ Soil Type Used.”

\* Note that final approval of a polymer is granted only after it is demonstrated through both the standpipe and field tests that the polymer is effective and can be effectively applied.

2. Mix the solutions by completely inverting each graduated cylinder 3 times.
3. Add polymer mixture to each graduated cylinder. The volume and concentration of polymer added is the manufacturer’s or supplier’s choice, but must include a set volume and a gradient of “low” to “high” concentrations. The volume and each polymer concentration must be recorded on the data sheet. The purpose is to determine the lowest polymer mixture concentration needed to achieve effective removal of suspended solids. Ultimately the least amount of polymer mixture needed to achieve optimal performance should be used in the field.

A minimum gradient of five polymer mixture concentrations is used to achieve the above stated purpose. The purpose of the five concentration gradient is to attempt to pinpoint the concentration that achieves optimal removal of suspended solids (i.e. least amount of polymer mixture required to remove a minimum of 95% of the suspended solids). This gradient should be sufficiently wide to show a range of effectiveness in removing suspended solids (with at least one, but preferably more, meeting the 95% removal level). A second goal of using a minimum of five concentrations is to avoid the occurrence of false negative outcomes in the polymer approval process. By having more concentrations across a gradient it is more likely to find truly effective concentrations that are less than the use restriction value. As is graphically depicted in Figure I, a polymer mixture will not be approved for field testing, and thus for inclusion on the PAL if its effective concentration (as determined in this laboratory stand pipe test) is greater than the use restriction value.

4. Mix the solutions by completely inverting each graduated cylinder 3 times.
5. Let the solution in each graduated cylinder settle for 5 minutes.
6. Determine the percent suspended solids reduction in each graduated cylinder as follows:
  - a. Heat/dry one evaporating or drying dish at 103 – 105°C for 1 hour for each graduated cylinder. Store the dishes in a desiccator until needed (steps b).
  - b. Weigh a dish out to at least one, and preferably more decimal points. Record this weight on the data sheet.
  - c. Collect 20 ml from within one of the graduated cylinders at the 1 liter mark and place in a preweighed evaporating or drying dish (from step a). Repeat steps b and c for each of the other graduated cylinders.
  - d. Evaporate and dry each of the 20 ml samples from step b at 98 °C for at least 1 hour.
  - e. Cool each dish with sample in a desiccator to balance temperature

- f. Weigh each dish with sample. Record this weight on the data sheet.
- g. Subtract the weight of the dried dish (from step b) to determine the weight of the solids from the sample. Record this weight on the data sheet.

\* These methods follow, with slight modification, those of Standard Methods 2540 B. (1989).

7. The polymer passes this effectiveness test if it achieves  $\geq 95\%$  reduction of suspended solids. Thus,  **$\geq 95\%$  reduction is achieved if the weight of the solids from the sample is  $\leq 0.2$  mg.**

$$\frac{2000 \text{ ml}^1}{1000 \text{ mg/L}^2} = \frac{20 \text{ ml}^3}{X^4} ; \quad X = 10 \text{ mg/L}$$

<sup>1</sup> = volume of solution in the cylinder

<sup>2</sup> = suspended solids concentration in the cylinder at  $\geq 95\%$  reduction

<sup>3</sup> = volume of sample taken from 1 L mark of the cylinder

<sup>4</sup> = sample solids concentration needed to achieve  $\geq 95\%$  reduction

$$\frac{10 \text{ mg}}{\text{L}} \times \frac{\text{L}}{1000 \text{ ml}} \times \frac{20 \text{ ml}}{1} = \mathbf{0.2 \text{ mg}}$$

8. A photocopy of the completed data sheet should be sent to the following address for WisDOT review:  
New Products Engineer, WisDOT, Technology Advancement, 3502 Kinsman Blvd., Madison, WI 53704.

#### References:

Owens, D.W., P. Jopke, D.W. Hall, J. Balousek, and A. Roa. 2000. *Soil erosion from two small construction sites, Dane County, Wisconsin*. U.S. Geological Survey Fact Sheet FS-109-00, 4 p.

Standard Methods Committee. 1989. 2540 Solids. In L.S. Clesceri, A. E. Greenberg, and R.R. Trussell, eds., *Standard Methods for the Examination of Water and Wastewater, 17<sup>th</sup> Edition*. American Public Health Association, Washington, DC. pp. 2-72 - 2-73.

**Interim Sediment Control  
Water Application of Polymers  
STANDPIPE TEST DATA SHEET**

Date(s): \_\_\_\_\_

Testing Laboratory: \_\_\_\_\_

Analyst(s) Initials: \_\_\_\_\_

Polymer Name: \_\_\_\_\_

Manufacturer Name: \_\_\_\_\_

Volume of Polymer Mixture Used: \_\_\_\_\_

√ Soil Type Used:     Clay     Silt     Site-Specific Soil  
(mechanical analysis results enclosed)

Polymer Mixture Concentration (mg/L or % solution)	Weight of Evaporating/Drying Dish		Final Weight of Solids Sample
	Pre	With Sample	

Which polymer mixture concentration(s) achieved effective ( $\geq 95\%$ ) reduction of suspended solids (i.e. final weight  $\leq 0.2$  mg solids)?

Notes/Comments: \_\_\_\_\_

Please send a photocopy of this completed data sheet to:

New Products Engineer, WisDOT, Technology Advancement, 3502 Kinsman B

## Erosion Control

### Land Application of Anionic Polyacrylamide

1050 (07/01)

Department of Natural Resources

Conservation Practice Standard

#### I. Definition

The land application of products containing watersoluble anionic polyacrylamide (PAM) as temporary soil binding agents to reduce erosion.

#### II. Purpose

The purpose of this practice is to reduce erosion from wind and water on construction sites and agricultural lands.

#### III. Conditions Where Practice Applies

This practice is intended for direct soil surface application to sites where the timely establishment of vegetation may not be feasible or where vegetative cover is absent or inadequate. Such areas may include agricultural lands where plant residues are inadequate to protect the soil surface and construction sites where land disturbing activities or winter shutdown prevent establishment or maintenance of a cover crop. This practice is not intended for application to surface waters of the state as defined by the Wisconsin Department of Natural Resources (WDNR) ch. [NR 102](#).

#### IV. Federal, State and Local Laws

Anionic PAM application shall comply with all federal, state, and local laws, rules or regulations governing anionic PAM. The operator is responsible for securing required permits. This standard does not contain the text of the federal, state, or local laws governing anionic PAM.

#### V. Criteria

- A. Toxicity Criteria. Anionic PAM mixtures shall be environmentally benign, harmless to fish, aquatic organisms, wildlife, and plants. Anionic PAM mixtures shall be non-combustible.
  1. Cationic PAM shall not be used at any level because its toxicity to aquatic test species occurs at very low concentrations.
  2. Anionic PAM mixtures shall have \_ .05% free acrylamide monomer by weight as established by the Food and Drug Administration (FDA) and the Environmental Protection Agency (EPA).
  3. Each manufacturer or supplier shall provide to the WDNR acute toxicity test data from a certified lab, as defined in ch. [NR 149](#) Wis. Adm. Code, for their anionic PAM mixture. Procedures specified in the "State of Wisconsin Aquatic Life Toxicity Testing Methods Manual", WDNR, as referenced in s. [NR 219.04](#), Wis. Adm. Code shall be used. The WDNR use restriction shall be developed from this data.
  4. Users of anionic PAM mixtures shall obtain and follow all Material Safety Data Sheet requirements, manufacturer recommendations, and WDNR use restrictions.
- B. Application Criteria
  1. The manufacturer or supplier shall provide a product expiration date for anionic PAM mixtures based on product expiration date of PAM in pure form. The manufacturer or supplier shall provide general written application methods, based on site conditions, such as slope and soil type.
  2. Application rates shall not exceed manufacturer's written application rate recommendations that shall not exceed the WDNR use restrictions.
  3. Maximum application rates, in parts per million (ppm or mg/L or mg/kg), shall be determined by multiplying 1.4 by the number of pounds applied per acre. This number shall be less than or equal to the WDNR use restriction. Higher concentrations of anionic PAM mixtures may actually decrease effectiveness. Repeated applications of anionic PAM mixtures may be applied, if necessary, to ensure adequate effectiveness.
  4. The application method shall provide uniform coverage to the target area and avoid drift to non-target areas.

5. The manufacturer or supplier shall provide written instructions to insure proper safety, storage, and mixing of their product.
6. Anionic PAM mixtures shall be used in conjunction with other Best Management Practices (BMPs).
7. When used on bare soil, without seed or mulch, anionic PAM mixtures shall be used on slopes 2.5:1 or flatter.
8. Anionic PAM mixtures shall not be applied to channel bottoms.
9. The applicator of anionic PAM mixture shall document, at the time of application, the following: name of applicator, application rate per acre, date applied, product type, weather conditions during application, and method of application. Copies of this documentation shall be entered into the contractor's monitoring log or project diary and made available upon request.
10. Unused liquid anionic PAM mixtures shall be minimized. Excess material shall not be applied at a rate greater than the maximum application rate. Disposal shall not occur in stormwater conveyance systems (ie. Storm sewer manholes, storm sewer inlets, ditches, and culverts).

#### C. Product Approval Criteria

1. Toxicity test results shall be reviewed by the WDNR and shall receive a written product use restriction. Toxicity test results shall be submitted to: Water Quality Standards Section, WDNR, 101 South Webster St., P.O. Box 7921, Madison, WI 53707, as a pre-qualification for field testing.
2. Anionic PAM mixtures shall achieve \_ 80% reduction in soil loss as measured by a 1 hour storm duration 2"/hour rainfall simulator test performed in accordance with methods used by Bubenzer and Patterson (1982) as a prequalification for field testing.
3. Performance of anionic PAM mixtures shall be verified and field-tested by the WisDOT or other WisDOT-designated facility.
4. The Wisconsin Department of Transportation, Erosion Control Storm Water – Product Acceptability List Committee (ECSW), will review and approve products as per the process set forth in WisDOT's PAL. **Only products approved for use in Wisconsin may be used.** Copies of the PAL are available off the State DOT web site: <http://www.dot.state.wi.us>. Questions may be sent to: New Products Engineer, WisDOT, Technology Advancement, 3502 Kinsman Blvd., Madison, WI 53704.

## VI. Considerations

The following are additional recommendations, which may enhance the use of, or avoid problems with the practice.

- A. Adding seed to the anionic PAM mixture may provide additional erosion protection beyond the life of the anionic PAM.
- B. Mulching is typically needed to protect the seed from the effects of wind and sun. Seed germination is not enhanced or impeded by the anionic PAM mixture.
- C. Using a minimum 30 ft setback when applying anionic PAM mixture near surface waters of the state is recommended.
- D. Applying anionic PAM mixture to soil may provide benefits of improved water quality, infiltration, soil fertility, and visibility by reducing wind and water erosion.
- E. For erosion control, the anionic PAM mixture may be applied upgradient of lands planted in food crops.
- F. Application of anionic PAM mixture may be particularly effective in the following situations:
  - During rough grading operations
  - Phased construction projects
  - Stockpiles
  - After final grading and before paving or final seeding and planting
  - Sites having a winter shutdown
  - Agricultural lands where plant residues are inadequate
  - Sites receiving final landscaping, but where adequate vegetation cannot be established prior to winter.
- G. Application of anionic PAM mixture may not be as effective in the following situations:
  - When the soil surface is pure sand or gravel with no fines.
  - When applied over snow cover.
- H. Visible tracer or colorant to visually track application is recommended.

- I. Anionic PAM mixtures may be applied in liquid and granular forms.
- J. Application rates of anionic PAM mixtures may need to be adjusted based on soil type, slope, and type of erosion targeted (ie. wind or water). Based on manufacturer's recommendations, higher application rates may be necessary when applied in granular form.
- K. Anionic PAM mixtures combined with water are very slippery and can be a safety hazard. Care must be taken to prevent spills of anionic PAM mixtures onto paved surfaces. During an application of anionic PAM mixture, prevent over-spray from reaching pavement, as pavement will become slippery.
- L. Care should be taken when applying anionic PAM mixtures in liquid form on saturated slopes due to the possibility of slope structural failure. Anionic PAM mixtures may be applied to steeper slopes when used with other erosion control BMPs such as seed and mulch or erosion mat.

## VII. Specifications

Erosion control and stormwater plans specifying anionic PAM mixtures for erosion control shall be in keeping with this standard and shall describe the requirements for applying the practice to achieve its intended purpose.

## VIII. Operation and Maintenance

Maintenance will consist of reapplying anionic PAM mixtures to disturbed areas, including high use traffic areas, which interfere in the performance of this practice. Anionic PAM mixture may lose its effectiveness in as little as two months due to weather conditions. Anionic PAM mixtures should be reapplied in areas where wind or rill erosion is apparent and whenever an area has been graded, driven upon, or otherwise disturbed since the anionic PAM mixture was last applied.

## IX. References

Bubbenzer, G.D., and Patterson, A.E., *Intake Rate: Sprinkler Infiltrometer*; Method of Soil Analysis, Part 1 Physical and Mineralogical Method, Second Edition, Chapter 33, pp. 845–870. (Agronomy Monograph Series #9, 1982). *Managing Irrigation-Induced Erosion And Infiltration With Polyacrylamide, Proceedings From First Conference*, University of Idaho Miscellaneous Publication No. 101–96, (Kimberly, Idaho, USDA–ARS Northwest Irrigation and Soils Research Lab, 1996).

Roa–Espinosa, A., Bubbenzer, G.D. and Miyashita, E., *Sediment and Runoff Control on Construction Sites Using Four Application Methods of Polyacrylamide Mix*, National Conference on Tools for Urban Water Resource Management and Protection, Chicago, February 7–10, 2000, pp. 278– (EPA, 2000).

Roa–Espinosa, A., Bubbenzer, G.D. and Miyashita, E., *Determination of PAM Use in Erosion Control on Construction Sites*, 1<sup>st</sup> Inter–Regional Conference on Environment–Water: Innovative Issues in Irrigation and Drainage, Lisbon, Portugal, September 1998 (Portuguese National Committee of ICID, 1998).

Roa–Espinosa, A., *Are there Safety Concerns or Environmental Concerns with PAM?* (Dane County Land Conservation Department, 1997).

Sojka, R.E. and Lentz, R.D., “A PAM Primer: A brief history of PAM and PAM related issues,” <http://kimberly.ars.usda.gov>, (Kimberly, ID: USDA–ARS Northwest Irrigation and Soils Research Lab, 1996).

Wisconsin Administration Code (Wis.Adm.Code), Legislative Reference Bureau, Section 35.84 of the statutes (available online: <http://legis.wisconsin.gov/rsb/code.htm>).

*Special recognition goes to Steve Decker* of Construction Fabrics & Materials Corp. (CFM). Steve was invaluable during the development of this technical standard because of his extensive field experience, his personal commitment to funding the research for toxicity testing, his vision and his steadfast determination to find an environmentally safe and effective erosion control product.

## Mulching For Construction Sites

**1058 (06/03)**

Wisconsin Department of Natural Resources

Conservation Practice Standard

**Note:** Words in the standard that are shown in italics are described in X. Definitions. The words are italicized the first time they are used.

### I. Definition

Mulching is the application of organic material to the soil surface to protect it from raindrop impact and overland flow. Mulch covers the soil and absorbs the erosive impact of rainfall and reduces the flow velocity of runoff.

### II. Purpose

This practice may be used to:

- Reduce soil erosion
- Aid in seed germination and establishment of plant cover
- Conserve soil moisture

### III. Conditions Where Practice Applies

This practice may be applied on exposed soils as a temporary control where soil grading or landscaping has taken place or in conjunction with temporary or permanent seeding. Mulching is generally not appropriate in areas of concentrated flow.

### IV. Federal, State, and Local Laws

Users of this standard shall comply with applicable federal, state and local laws, rules, regulations or permit requirements governing mulching. This standard does not contain the text of federal, state, or local laws.

### V. Criteria

This section establishes the minimum standards for design, installation and performance requirements.

#### A. Site Preparation:

Soil surface shall be prepared prior to the application of mulch in order to achieve the desired purpose and to ensure optimum contact between soil and mulch. All areas to be mulched shall be reasonably free of rills and gullies.

#### B. Materials:

Mulch shall consist of natural biodegradable material such as plant residue (including but not limited to straw, hay, wood chips, bark and wood cellulose fiber), or other equivalent materials of sufficient dimension (depth or thickness) and durability to achieve the intended effect for the required time period.

Mulch shall be environmentally harmless to wildlife and plants. Materials such as gravel, plastic, fabric, sawdust, municipal solid waste, *solid waste byproducts*<sup>1</sup>, shredded paper, and non-biodegradable products shall not be used.

Mulch shall be free of diseased plant residue (i.e. oak wilt), *noxious weed* seeds, harmful chemical residues, heavy metals, hydrocarbons and other known environmental toxicants.

Marsh hay shall not be used as mulch in lowland areas but may be used on upland sites to prevent the spread of invasive, non-native species (i.e. reed canary grass) commonly found in marsh hay.

Straw and hay mulch that will be crimped shall have a minimum fiber length of 6 inches.

Wood chips or wood bark shall only be used for sites that are not seeded.

## C. Application Rate:

1. Mulch shall cover a minimum of 80% of the soil surface for unseeded areas. For seeded areas, mulch shall be placed loose and open enough to allow some sunlight to penetrate and air to circulate but still cover a minimum of 70% of the soil surface.
2. Mulch shall be applied at a uniform rate of 1½ to 2 tons per acre for sites that are seeded, and 2 to 3 tons per acre for sites that are not seeded. This application results in a layer of ½ to 1½ inches thick for seeded sites, and 1½ to 3 inches thick for sites not seeded.
3. Wood chips or wood bark shall be applied at a rate of 6 to 9 tons per acre to achieve a minimum of 80% ground cover. This application should result in a layer of wood chips or wood bark ½ to 1½ inches thick.

## D. Mulch Anchoring Methods

Anchoring of mulch shall be based on the type of mulch applied, site conditions, and accomplished by one of the following techniques:

## 1. Crimping

Immediately after spreading, the mulch shall be anchored by a mulch crimper or equivalent device consisting of a series of dull flat discs with notched edges spaced approximately 8 inches apart. The mulch shall be impressed in the soil to a depth of 1 to 3 inches.

## 2. Polypropylene Plastic, or Biodegradable Netting

Apply plastic netting over mulch application and staple according to manufacturer's recommendations.

## 3. Tackifier

Tackifier shall be sprayed in conjunction with mulch or immediately after the mulch has been placed. Tackifiers must be selected from those that meet the WisDOT Erosion Control Product Acceptability List (PAL). Asphalt based products shall not be applied.

The tackifiers shall be applied at the following minimum application rates per acre:

- a. Latex–Base: mix 15 gallons of adhesive (or the manufacturer's recommended rate which ever is greater) and a minimum of 250 pounds of recycled newsprint (pulp) as a tracer with 375 gallons of water.
- b. Guar Gum: mix 50 pounds of dry adhesive (or the manufacturer's recommended rate which ever is greater) and a minimum of 250 pounds of recycled newsprint (pulp) as tracer with 1,300 gallons of water.
- c. Other Tackifiers: (Hydrophilic Polymers) mix 100 pounds of dry adhesive (or the manufacturer's recommended rate which ever is greater) and a minimum of 250 pounds of recycled newsprint (pulp) as a tracer with 1,300 gallons of water.

**VI. Considerations**

- A. Wood products typically absorb available soil nitrogen as they degrade, thus making it unavailable for seed.
- B. The use of mulch behind curb and gutter may not be desirable unless anchored by netting, because air turbulence from nearby traffic can displace the mulch. Consider the use of erosion mat or sod as an alternative.
- C. In areas where lawn type turf will be established, the use of tackifiers is the preferred anchoring method. Crimping will tend to leave an uneven surface and plastic netting can become displaced and entangled in mowing equipment.
- D. A heavier application of mulch may be desired to prevent seedlings from being damaged by frost.
- E. It may be beneficial to apply polyacrylimide in addition to mulch. Refer to WDNR Conservation Practice Standard (1050) Erosion Control Land Application of Anionic Polyacrylamide for information about the advantages and proper use of polymers.
- F. Concentrated flows above the site where mulch is applied should be diverted.
- G. Mulch should be placed within 24 hours of seeding.
- H. Mulching operations should not be performed during periods of excessively high winds that would preclude the proper placement of mulch.
- I. Materials such as gravel may be effective for erosion control but are not considered mulches.

## VII. Plans and Specifications

- A. Plans and specifications for mulching shall be in keeping with this standard and shall describe the requirements for applying the practice to achieve its intended purpose. The plans and specifications shall address the following:
  - 1. Type of mulch used
  - 2. Application rate
  - 3. Timing of application
  - 4. Method of anchoring
- B. All plans, standard detail drawings, or specifications shall include schedules for installation, inspection, and maintenance. The responsible party shall be identified.

## VIII. Operation and Maintenance

Mulch shall, at a minimum, be inspected weekly and within 24 hours after every precipitation event that produces 0.5 inches of rain or more during a 24 hour period.

Mulch that is displaced shall be reapplied and properly anchored. Maintenance shall be completed as soon as possible with consideration to site conditions.

## IX. References

WisDOT's Erosion Control Product Acceptability List (PAL) can be found on the WisDOT web site: <http://www.dot.wisconsin.gov/business/engrserv/pal.htm>. Printed copies are no longer being distributed.

## X. Definitions

*Noxious weed* (V.B): Any weed a governing body declares to be noxious within its respective boundaries. The State of Wisconsin list of noxious weeds can be found in s. 66.0407, Stats.

*Solid Waste Byproducts* (V.B): Includes industrial, commercial, residential, and agricultural wastes that have been processed, incinerated, or composted and still contain inorganic wastes such as glass and metals and organic wastes including plastics, textiles, rubber, leather, and other miscellaneous organic wastes which may be toxic or hazardous in nature.

## Non-Channel Erosion Mat

1052 (08/03)

Wisconsin Department of Natural Resources  
Conservation Practice Standard

**Note:** Words in the standard that are shown in italics are described in X. Definitions. The words are italicized the first time they are used.

### I. Definition

A protective soil cover made of straw, wood, coconut fiber or other suitable plant residue, or plastic fibers formed into a mat, usually with a plastic or biodegradable mesh on one or both sides. Erosion mats are rolled products available in many varieties and combinations of material and with varying life spans.

### II. Purpose

The purpose of this practice is to protect the soil surface from the erosive effect of rainfall and prevent *sheet erosion*<sup>1</sup> during the establishment of grass or other vegetation, and to reduce soil moisture loss due to evaporation. This practice applies to both *Erosion Control Revegetative Mats (ECRM)* and *Turf-Reinforcement Mats (TRM)*.

### III. Conditions Where Practice Applies

This standard applies to erosion mat selection for use on erodible slopes.

This standard is not for channel erosion; for channel applications reference WDNR Conservation Practice Standard (1053) Channel Erosion Mat.

### IV. Federal, State, and Local Laws

Users of this standard shall be aware of applicable federal, state, and local laws, rules, regulations, or permit requirements governing the use and placement of erosion mat. This standard does not contain the text of federal, state, or local laws.

### V. Criteria

This section establishes the minimum allowable standards for design, installation and performance requirements. Only Wisconsin Department of Transportation (WisDOT) Erosion Control Product Acceptability List (PAL) approved mats will be accepted for use in this standard.

Slope and slope length shall be taken into consideration. This information can be found in the Slope Erosion Control Matrix located in the PAL.

To differentiate applications Erosion mats are organized into three Classes of mats, which are further broken down into various Types.

- A. Class I: A short-term duration (minimum of 6 months), light duty, organic mat with photodegradable plastic or biodegradable netting.
  - 1. Type A – Use on erodible slopes 2.5:1 or flatter.
  - 2. Type B – Double netted product for use on erodible slopes 2:1 or flatter.
- B. Class I, Urban: A short-term duration (minimum of 6 months), light duty, organic erosion control mat for areas where mowing may be accomplished within two weeks after installation.
  - 1. Urban, Type A – Use on erodible soils with slopes 4:1 or flatter.
  - 2. Urban, Type B – A double netted product for use on slopes 2.5:1 or flatter.
- C. Class II: A long-term duration (three years or greater), organic erosion control revegetative mat.
  - 1. Type A – Jute fiber only for use on slopes 2:1 or flatter for sod reinforcement.
  - 2. Type B – For use on slopes 2:1 or greater made with plastic or biodegradable net.
  - 3. Type C – A woven mat of 100% organic fibers for use on slopes 2:1 or flatter and in environmentally and biologically sensitive areas where plastic netting is inappropriate.

- D. Class III: A permanent 100% synthetic ECRM or TRM. Either a soil stabilizer Type A or Class I, Type A or B erosion mat must be placed over the soil filled TRM.
  - 1. Type A – An ECRM for use on slopes 2:1 or flatter.
  - 2. Type B or C – A TRM for use on slopes 2:1 or flatter.
  - 3. Type D – A TRM for use on slopes 1:1 or flatter.
- E. Material Selection
  - 1. For mats that utilize netting, the netting shall be bonded to the parent material to prevent separation of the net for the life of the product.
  - 2. For urban class mats the following material requirements shall be adhered to:
    - a. Only 100% organic biodegradable netted products are allowed, including parent material, stitching, and netting.
    - b. The netting shall be stitched with biodegradable thread/yarn to prevent separation of the net from parent material.
    - c. All materials and additive components used to manufacture the anchoring devices shall be completely biodegradable as determined by ASTM D 5338.
    - d. Mats with photodegradable netting shall not be installed after September 1<sup>st</sup>.
- F. Installation
  - 1. ECRMs shall be installed after all topsoiling, fertilizing, liming and seeding is complete.
  - 2. The mat shall be in firm and intimate contact with the soil. It shall be installed and anchored per the manufacturer's recommendation.
  - 3. TRM shall be installed in conjunction with the topsoiling operation and shall be followed by ECRM installation.
  - 4. At time of installation, document the manufacturer and mat type by retention of material labels and manufacturer's installation instructions. Retain this documentation until the site has been stabilized.

## VI. Considerations

- A. Urban mats may be used in lieu of sod.
- B. Documentation of materials used, monitoring logs, project diary and weekly inspection forms, including erosion and stormwater management plans, should be turned over to the authority charged with long term maintenance of the site.

## VII. Plans and Specifications

- A. Plans and specifications for installing erosion mat shall be in keeping with this standard and shall describe the requirements for applying the practice to achieve its intended purpose. The plans and specifications shall address the following:
  - 1. Location of erosion mat
  - 2. Installation Sequence
  - 3. Material specification conforming to standard
- B. All plans, standard detail drawings, or specifications shall include schedule for installation, inspection, and maintenance. The responsible party shall be identified.

## VIII. Operation and Maintenance

- A. Erosion mat shall at a minimum be inspected weekly and within 24 hours after every precipitation event that produces 0.5 inches of rain or more during a 24-hour period.
- B. If there are signs of rilling under the mat, install more staples or more frequent anchoring trenches. If rilling becomes severe enough to prevent establishment of vegetation, remove the section of mat where the damage has occurred. Fill the eroded area with topsoil, compact, reseed and replace the section of mat, trenching and overlapping ends per manufacturer's recommendations. Additional staking is recommended near where rilling was filled.

- C. If the reinforcing plastic netting has separated from the mat, remove the plastic and if necessary replace the mat.
- D. Maintenance shall be completed as soon as possible with consideration to site conditions.

## IX. References

WisDOT “Erosion Control Product Acceptability List” is available online at <http://www.dot.wisconsin.gov/business/engrserv/pal.htm>. Printed copies are no longer distributed.

## X. Definitions

*Sheet and Rill Erosion (II)*: Sheet and rill erosion is the removal of soil by the action of rainfall and shallow overland runoff. It is the first stage in water erosion. As flow becomes more concentrated rills occur. As soil detachment continues or flow increases, [rills](#) will become wider and deeper forming gullies.

*Erosion Control Revegetative Mats (ECRM) (II)*: Erosion control revegetative mats are designed to be placed on the soil surface.

*Turf-Reinforcement Mats (TRM) (II)*: Turf-reinforcement mats are permanent devices constructed from various types of synthetic materials and buried below the surface to help stabilize the soil. TRMs must be used in conjunction with an ECRM or an approved Type A soil stabilizer.

## Sediment Bale Barrier

### (Non-Channel)

1055 (08/03)

Wisconsin Department of Natural Resources

Conservation Practice Standard

**Note:** Words in the standard that are shown in italics are described in IX. Definitions. The words are italicized the first time they are used.

### I. Definition

A temporary sediment barrier consisting of a row of entrenched and anchored straw bales, hay bales or equivalent material used to intercept sediment-laden sheet flow from small drainage areas of disturbed soil.

### II. Purpose

The purpose of this practice is to reduce slope length of the disturbed area and to intercept and retain transported sediment from disturbed areas.

### III. Conditions Where Practice Applies

A. This standard applies to the following applications where:

1. Erosion occurs in the form of *sheet and rill erosion*<sup>1</sup>. There is no concentration of water flowing to the barrier (*channel erosion*).
2. Where adjacent areas need protection from sediment-laden runoff.
3. Effectiveness is required for less than 3 months.
4. Conditions allow for the bales to be properly entrenched and staked as outlined in the Criteria Section V.

B. Under no circumstance shall sediment bale barriers be used in the following applications:

1. Below the ordinary high watermark or placed perpendicular to flow in streams, swales, ditches or any place where flow is concentrated.
2. Where the maximum gradient upslope of the sediment bale barriers is greater than 50% (2:1).

### IV. Federal, State, and Local Laws

Users of this standard shall be aware of applicable federal, state, and local laws, rules, regulations, or permit requirements governing the use and placement of the sediment bale barrier. This standard does not contain the text of federal, state, or local laws.

### V. Criteria

This section establishes the minimum standards for design, installation and performance requirements.

A. Placement

1. At a minimum, sediment bale barriers shall be placed in a single row, lengthwise on the contour, with the ends of adjacent sediment bale barriers tightly abutting one another. The holes between bales shall be chinked (filled by wedging) with straw, hay or equivalent material to prevent water from escaping between the bales.
2. The maximum allowable slope lengths contributing runoff to a sediment bale barrier are specified in Table 1.

Table 1

Slope	Barrier Row Spacing
< 2%	100 feet
2 to 5%	75 feet
5 to 10%	50 feet
10 to 33%	25 feet
33 to 50%	20 feet
> 50%	Not Permitted

3. Sediment bale barriers shall not be placed perpendicular to the contour.
  4. The end of the sediment bale barrier shall be extended upslope to prevent water from flowing around the barrier ends.
- B. Height – Installed sediment bale barrier shall be a minimum of 10 inches high and shall not exceed a maximum height of 20 inches from ground level.
- C. Anchoring and Support
1. The barrier shall be entrenched and backfilled. A trench shall be excavated the width of a sediment bale barrier and the length of the proposed barrier to a minimum depth of 4 inches. After bales are staked and chinked, the excavated soil shall be backfilled and compacted against the barrier. Backfill to ground level on the down slope side. On the upslope side of the sediment bale barrier backfill to 4 inches above ground level.
  2. At least two wood stakes, “T” or “U” steel posts, or ½ inch rebar driven through at equidistance along the centerline of the barrier shall securely anchor each bale. The minimum cross sectional area for wood stakes shall be 2.0 by 2.0 inches nominal. The first stake in each bale shall be driven toward the previously laid bale to force the bales together. Stakes shall be driven a minimum 12–inches into the ground to securely anchor the sediment bale barriers.
  3. Bales shall be installed so that bindings are oriented around the sides rather than along the tops and bottoms of the bales in order to prevent deterioration of the bindings.

## VI. Considerations

- A. Improper placement as well as improper installation and maintenance of sediment bale barriers will significantly decrease the effectiveness of this practice.
- B. Sediment bale barriers should not be used upslope of the disturbed area.
- C. A double row of sediment bale barriers may be installed in areas where additional protection is needed.
- D. For safety, place all anchoring flush with the sediment bale barrier or cap any exposed anchoring device.

## VII. Plans and Specifications

- A. Plans and specifications for installing sediment bale barriers shall be in keeping with this standard and shall describe the requirements for applying the practice to achieve its intended purpose. The plans and specifications shall address the following:
  1. Location of sediment bale barrier
  2. Contributory drainage area
  3. Schedules
  4. Standard drawings and installation details
  5. Restoration after removal
- B. All plans, standard detail drawings, or specifications shall include schedule for installation, inspection, and maintenance. The responsible party shall be identified.

## VIII. Operation and Maintenance

- A. Sediment bale barriers shall, at a minimum, be inspected weekly and within 24 hours after every precipitation event that produces 0.5 inches of rain or more during a 24–hour period.

- B. Damaged or decomposed sediment bale barriers, any undercutting, or flow channels around the end of the sediment bale barriers shall be repaired.
- C. Sediment shall be properly disposed of once the deposits reach 1/2 the height of the sediment bale barrier.
- D. Sediment bale barriers and anchoring devices shall be removed and properly disposed of when they have served their usefulness, but not before the upslope areas have been permanently stabilized.
- E. Any sediment deposits remaining in place after the sediment bale barrier is no longer required shall be dressed to conform to the existing grade, prepared and seeded.

## IX. Definitions

*Channel Erosion* (III.A.1): The deepening and widening of a channel due to soil loss caused by flowing water. As rills become larger and flows begin to concentrate soil detachment occurs primarily as a result of shear. The transport capacity of the flow in a channel is based on the availability of sediment and is a monatomic function of velocity.

*Sheet and Rill Erosion* (III.A.1): Sheet and rill erosion is the removal of soil by the action of rainfall and shallow overland runoff. It is the first stage in water erosion. As flow becomes more concentrated rills occur. As soil detachment continues or flow increases, rills will become wider and deeper forming gullies.

## Sediment Basin

1064 (03/06)

Wisconsin Department of Natural Resources

Conservation Practice Standard

**Note:** Words in the standard that are shown in italics are described in X. Definitions. The words are italicized the first time they are used.

### I. Definition

A sediment control device constructed with an engineered outlet, formed by excavation or embankment to intercept sediment-laden runoff and retain the sediment.

### II. Purposes

Detain sediment-laden runoff from disturbed areas for sufficient time to allow the majority of the sediment to settle out.

### III. Conditions Where Practice Applies

Sediment basins are utilized in areas of concentrated flow or points of discharge during construction activities. Sediment basins shall be constructed at locations accessible for clean out. Site conditions must allow for runoff to be directed into the basin.

Sediment basins are designed to be in place until the contributory drainage area has been *stabilized*<sup>1</sup>. Sediment basins are temporary and serve drainage areas up to 100 acres however other conservation practices are often more economical for smaller drainage areas. For drainage areas smaller than 5 acres sediment traps or ditch checks may be applicable; for design criteria refer to WDNR conservation Practice Standard Sediment Trap (1063) or Ditch Check (1062).

Design to WDNR Conservation Practice Standard Wet Detention Basin (1001) when a permanent stormwater basin is required.

### IV. Federal, State, and Local Laws

Users of this standard shall be aware of applicable federal, state, and local laws, rules, regulations, or permit requirements governing the use and placement of sediment basins. This standard does not contain the text of federal, state, or local laws.

### V. Criteria

This section establishes the minimum standards for design, installation and performance requirements. Sediment basins meeting these design criteria are deemed 80% effective by design in trapping sediment.

- A. Timing – Sediment basins shall be constructed prior to disturbance of up-slope areas and placed so they function during all phases of construction. Sediment basins shall be placed in locations where runoff from disturbed areas can be diverted into the basin.
- B. Sizing Criteria – Properly sized sediment basins are more effective at trapping fine-grained particles than sediment traps. Specific trapping efficiency varies based on the surface area and the particle size distribution of the sediment entering the device. See Figure 1 for clarification of terms. Attachment 1 includes a sample design problem.

*Treatment Surface Area* – The surface area of the sediment basin measured at the invert of the lowest outlet. The treatment surface area shall be sized based on the texture of the soil entering the device and the peak outflow during the 1-year, 24-hour design storm using Equation 1:

$$S_a = 1.2 * (q_{out} / v_s)$$

Where:

$S_a$  = Treatment surface area measured at the invert of the lowest outlet of sediment basin (square feet)

$q_{out}$  = Peak outflow (cubic feet / second) during the 1-year, 24-hour design storm for the principal outlet

$v_s$  = Particle settling velocity (feet/second)

1.2 = EPA recommended safety factor

Particle settling velocities ( $V_s$ ) shall be based on representative soil class as follows:

- a. Soil Class 1:  $v_s = 1.2 \times 10^{-3}$  ft/sec
- b. Soil Class 2:  $v_s = 7.3 \times 10^{-5}$  ft/sec
- c. Soil Class 3:  $v_s = 1.2 \times 10^{-5}$  ft/sec

**Note:** Particle settling velocities calculated assuming a specific gravity of 2.65 and a water temperature of 68 degrees Fahrenheit.

Soil Class 1 includes particles greater than 20 microns generally corresponding to sand, loamy sand, and sandy loam.

Soil Class 2 includes particles between 5 and 20 microns generally corresponding to loam, silt, and silt loam aggregates as transported in runoff.

Soil Class 3 includes particles between 2 and 5 microns generally corresponding to clay loam, silty clay, and clay aggregates as transported in runoff.

The representative soil class shall be selected based on the dominant textural class of the soil entering the device.

The treatment surface area of sediment basins can be reduced when used in conjunction with water applied polymers. When employing polymers, size the treatment surface area for controlling fine soils (Class 3) using the settling velocity for medium soils (Class 2). When designing for medium sized soils (Class 2) use the settling velocity for coarse soils (Class 1). See WDNR Conservation Practice Standard Sediment Control Water Application of Polymers (1051) for criteria governing the proper use and selection of polymers.

**Depth below Treatment Surface Area** – The depth below the treatment surface area as measured from the invert of the lowest outlet of the sediment basin shall be a minimum of 5 feet deep (2 feet for sediment storage plus 3 feet to protect against scour/ resuspension) and a maximum of 10 feet deep to limit the potential for thermal stratification.

Due to side slope requirements and safety shelf considerations it maybe difficult to maintain 5 feet of depth for the entire treatment surface area. Therefore, 50% of the total treatment surface area shall be a minimum of 5 feet deep. For basins less than 5,000 square feet, maximize the area of 5 feet depth.

Interior side slopes below the lowest invert shall be 2:1 (horizontal: vertical) or flatter to maintain soil stability.

While a permanent pool of water below the lowest invert may form, it is not required to be maintained through irrigation or installation of a liner system.

**Active Storage Volume** – The volume above the treatment surface area shall be calculated using one of the following methods:

- a. The method outlined in TR-55 for determining the storage volume for detention basins. This can be accomplished by using Figure 2 where:

$q_o$  = Peak outflow (cubic feet / second) during the 1-year, 24-hour design storm for the principal outlet calculated using Equation 1 (see section V.B.1).

$q_i$  = Calculated peak inflow or runoff rate (cubic feet / second) during the 1-year, 24-hour design storm.

$V_r$  = Calculated volume of runoff from the 1-year 24-hour design storm for the entire contributory area with the maximum area of disturbance characterized as bare soil.

$V_s$  = Is the required active storage volume determined using Figure 2.

- b. The active storage volume may be calculated based on routing the 1-year, 24-hour storm provided the principal outlet requirements stipulated in section V.D.2 are maintained. This method will require the use of a model.

**Note:** Both these methods require iterative calculations.

**Shape** – The length to width ratio of the flow path shall be maximized with a goal of 3:1 or greater. The flow path is considered the general direction of water flow within the basin including the treatment surface area and any forebay.

- C. Embankments – Earthen embankments shall be designed to address potential risk and structural integrity issues such as seepage and saturation. All constructed earthen embankments shall meet the following criteria.
  1. The base of the embankment shall be stripped of all vegetation, stumps, topsoil and other organic matter.
  2. Side slopes shall be 3:1 or flatter. The minimum embankment top width shall be adequate to provide structural stability. Where applicable the top width shall be wide enough to provide maintenance access.

3. There shall be a core trench or key-way along the embankment.

Any pipes extending through the embankment shall be bedded and backfilled with equivalent soils used to construct the embankment. The bedding and backfill shall be compacted in lifts and to the same standard as the original embankment. Excavation through a completed embankment shall have a minimum side slope of 1:1 or flatter.

Measures shall be taken to minimize seepage along any conduit buried in the embankment.

- D. Outlet – Sediment basins shall have both a principal outlet and an overflow spillway.

1. Timing – Outlets must be constructed in conjunction with the remainder of the basin and must be constructed prior to the basin receiving runoff. Sediment basins are ineffective until the outlet is constructed.
2. Principal Water Quality Outlet – The principal water quality outlet shall be designed to pass the 1-year 24-hour storm without use of the overflow spillway or other outlet structures. The maximum outflow ( $q_0$ ) from the principal water quality outlet shall be less than or equal to the  $q_0$  used in Equation 1 (V.B.1). If the sediment basin is to serve as a permanent stormwater basin, the principal outlet structure can be modified (i.e. removable plates) to meet flow requirements encountered during and after construction; separate outlet structures do not need to be constructed.

**Note:** Local ordinances may require control of larger storm events such as the 2-year 24 hour storms. In these cases, additional or compound outlets maybe required.

3. Overflow (Emergency) Spillway – An overflow spillway shall be provided consisting of an open channel constructed adjacent to the embankment and built over a stabilized area. The spillway shall be designed to carry the peak rate of runoff expected from a 10-year, 24-hour design storm or one commensurate with the degree of hazard, less any reduction due to flow in the principal outlet. The top of the embankment shall be at least one foot above the design high water level and a minimum of 1 foot above the invert of the overflow spillway. The overflow spillway shall be protected from erosion. Flow from the overflow spillway shall be directed away from the embankment.
  4. Outlet Protection – All outlet designs shall incorporate preventive measures for ice damage, trash accumulation, and erosion at the outfall. For orifices less than 8-inches in diameter, or equivalent, additional measures to prevent clogging are required.
- E. Inlet Protection – Inlets shall be designed to prevent scour and reduce velocities during peak flows. Possible design options include flow diffusion, plunge pools, directional berms, baffles, or other energy dissipation structures.
  - F. Location – Temporary sediment basins should be located to provide access for cleanout and disposal of trapped sediment.
  - G. Removal – Temporary sediment basins shall be removed after the contributing drainage area has been stabilized. Complete final grading and restoration according to the site plans. If standing water needs to be removed it shall be done in accordance with WDNR Conservation Practice Standard Dewatering (1061).

## VI. Considerations

- A. When constructing a sediment basin that will also serve as the long-term stormwater detention pond, build the sediment basin to the larger of the two sizes required either for stormwater control or erosion control. In addition, when sizing the outlet structure first design the outlet for the long-term stormwater management requirements then check to satisfy the flow requirements for sediment control during construction. If additional flow restriction is needed consider use of a temporary restriction plates or other measures to avoid having to construct separate outlet structures for the sediment basin and stormwater basin.
- B. Over-excavation beyond the required depth in the sediment storage area of the sediment basin may allow for less frequent maintenance. Addition of other measures in the contributing drainage area may reduce sediment accumulation and associated maintenance requirements.
- C. The use of a sediment forebay can extend the useful life of the main sediment storage area by trapping the majority of sediment in the forebay area. Separation of the forebay from the rest of the basin requires construction of a submerged shelf (if wet) or a stone or stabilized earthen embankment. The forebay should have a surface area equal to at least 12% of the total basin area.
- D. In addition to soil stability issues, interior slopes of sediment basins should be selected based on safety issues commensurate with the degree of hazard.

## VII. Plans and Specifications

- A. Plans and specifications for installing sediment basins shall be in keeping with this standard and shall describe the requirements for applying the practice to achieve its intended purpose.
  - 1. Location of sediment basin
  - 2. Schedules and sequence of installation and removal
  - 3. Standard drawings and installation details
  - 4. Control structure detail and layout
  - 5. Sizing of sediment storage area
  - 6. Maintenance requirements
- B. All plans, standard detail drawings, or specifications shall include sequence for installation, inspection, and maintenance requirements. The responsible party shall be identified.

## VIII. Operation and Maintenance

- A. Sediment basins shall, at a minimum, be inspected weekly and within 24 hours after every precipitation event that produces 0.5 inches of rain or more during a 24-hour period.
- B. Sediment shall be removed to maintain the three foot depth of the treatment surface area as measured from the invert of the principal outlet. Sediment may need to be removed more frequently.
- C. If the outlet becomes clogged it shall be cleaned to restore flow capacity.
- D. Provisions for proper disposal of the sediment removed shall be made.
- E. Maintenance shall be completed as soon as possible with consideration to site conditions.

## IX. References

Chapter [NR 333](#), Dam and Design Construction.

Hann, Barfield, and Hayes. Design Hydrology and Sedimentology for Small Catchments. Academic Press Inc., 1994.

Robert E. Pitt, Small Storm Hydrology.

US Bureau of Reclamation, Design of Small Dams. [http://www.usbr.gov/pmts/hydraulics\\_lab/pubs/index.cfm](http://www.usbr.gov/pmts/hydraulics_lab/pubs/index.cfm).

USDA, Natural Resources Conservation Service, Ponds – Planning, Design, Construction. Agriculture Handbook No. 590, Revised September 1997.

WDNR Conservation Practice Standard 1001 Wet Detention Basin.

## X. Definitions

*Active Storage Volume* (V.B.3) – Is measured from the invert of the lowest outlet to the invert of the emergency spillway.

*Stabilized (III)* – Means protecting exposed soil from erosion.

*Treatment Surface Area* (V.B.1) – Is the surface area of the sediment basin measured at the invert of the lowest outlet.

**Figure 1**  
**Clarification of Sediment Basin Terminology**

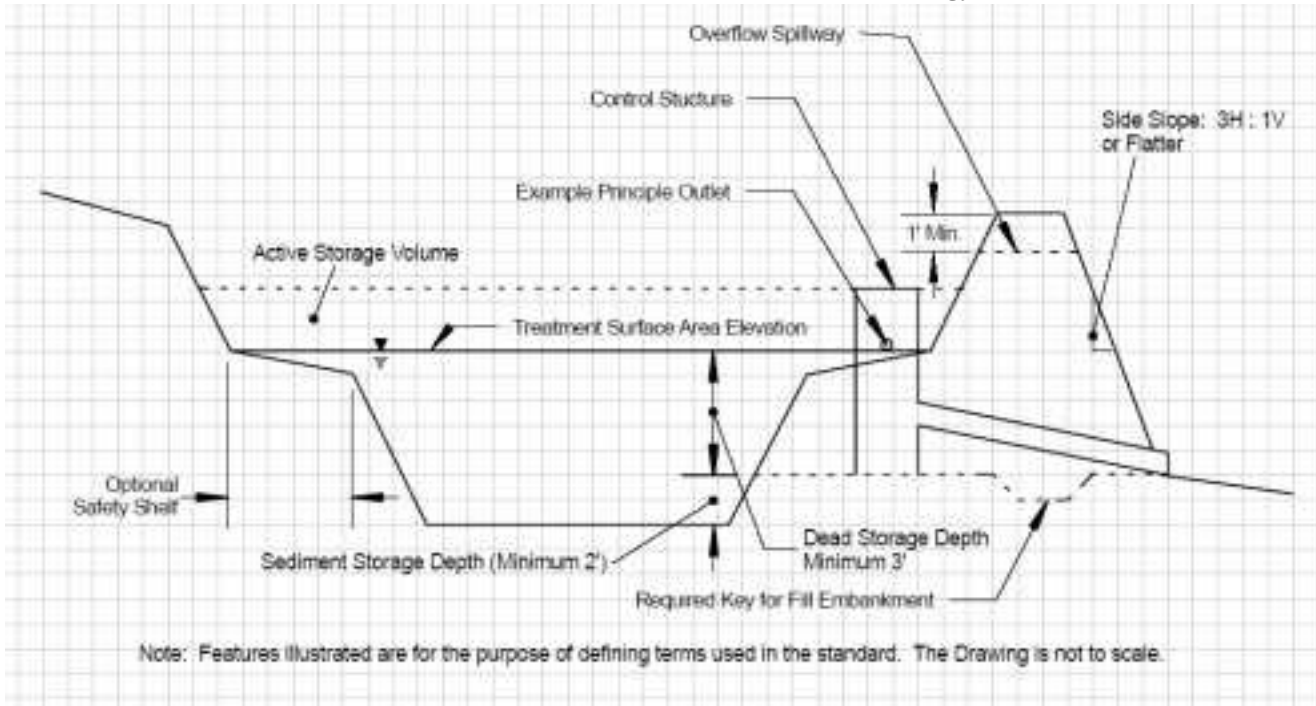
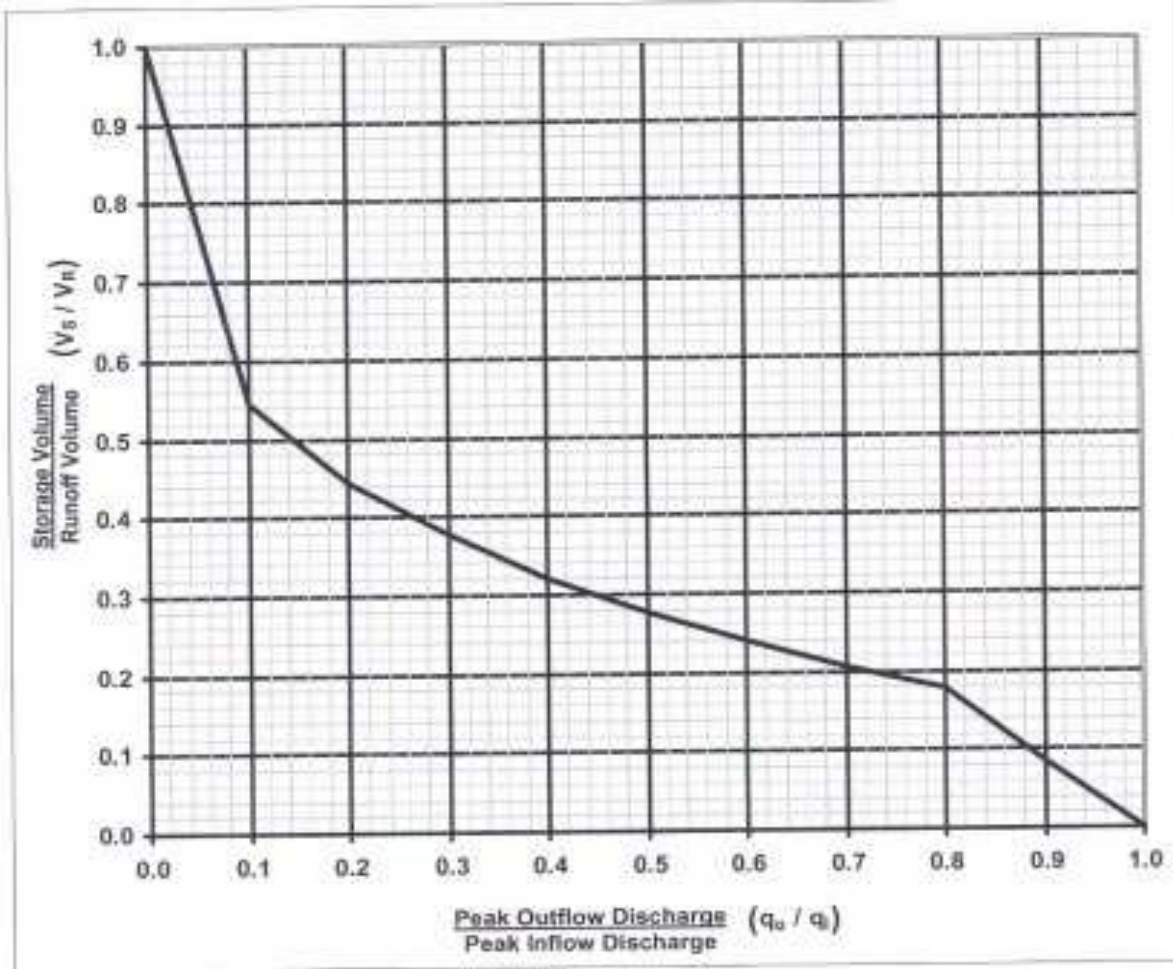

Figure 2  
Approximate Detention Basin Routing for Type II Storms



Source: Technical Release 55, United States Department of Agriculture, Natural Resources Conservation Service, Washington D.C. 1988

**Rainfall Quantities:**

Table 1 provides a summary of the 1-year, 24-hour rainfall totals using NRCS mandated TP-40 which has not been updated since 1961. Table 2 provides a summary of more current data from the Rainfall Frequency Atlas of the Midwest published in 1992. Local requirements may dictate the use of one dataset over the other.

**Table 1**  
**Rainfall for Wisconsin Counties for a 1-Year, 24-Hour Rainfall<sup>1</sup>**

Inches of Rainfall	County
2.1 in.	Door, Florence, Forest, Kewaunee, Marinette, Oconto, Vilas
2.2 in.	Ashland, Bayfield, Brown, Calumet, Douglas, Iron, Langlade, Lincoln, Manitowoc, Menominee, Oneida, Outagamie, Price, Shawano, Sheboygan
2.3 in.	Barron, Burnett, Dodge, Fond du Lac, Green Lake, Marathon, Milwaukee, Ozaukee, Portage, Racine, Rusk, Sawyer, Taylor, Washburn, Washington, Waukesha, Waupaca, Waushara, Winnebago, Wood
2.4 in.	Adams, Chippewa, Clark, Columbia, Dane, Dunn, Eau Claire, Jackson, Jefferson, Juneau, Kenosha, Marquette, Pepin, Pierce, Polk, Rock, St. Croix, Walworth
2.5 in.	Buffalo, Green, Iowa, La Crosse, Monroe, Richland, Sauk, Trempealeau, Vernon
2.6 in.	Crawford, Grant, Lafayette

<sup>1</sup>TP - 40 - Rainfall Frequency Atlas of the United States, U.S. Department of Commerce Weather Bureau.

**Table 2**  
**Rainfall for Wisconsin Counties for a 1-Year, 24-Hour Rainfall<sup>2</sup>**

Zone	Inches of Rainfall	County
1	2.22	Douglas, Bayfield, Burnett, Washburn, Sawyer, Polk, Barron, Rusk, Chippewa, Eau Claire
2	2.21	Ashland, Iron, Vilas, Price, Oneida, Taylor, Lincoln, Clark, Marathon
3	1.90	Florence, Forest, Marinette, Langlade, Menominee, Oconto, Door, Shawano
4	2.23	St. Croix, Dunn, Pierce, Pepin, Buffalo, Trempealeau, Jackson, La Crosse, Monroe
5	2.15	Wood, Portage, Waupaca, Juneau, Adams, Waushara, Marquette, Green Lake
6	1.96	Outagamie, Brown, Kewaunee, Winnebago, Calumet, Manitowoc, Fond Du Lac, Sheboygan
7	2.25	Vernon, Crawford, Richland, Sauk, Grant, Iowa, Lafayette
8	2.25	Columbia, Dodge, Dane, Jefferson, Green, Rock
9	2.18	Ozaukee, Washington, Waukesha, Milwaukee, Walworth, Racine, Kenosha

<sup>2</sup> Bulletin 71: Rainfall Frequency Atlas of the Midwest, Midwest Climate Center and Illinois State Water Survey, 1992.

## Attachment 1

### Sample Sediment Basin Design Problem

The proper sizing and design of a sediment basin will often require iterative calculations. The technical standard for sizing sediment basins was written to give the designer as much flexibility as possible in designing the basin while meeting water quality requirements. The governing equation relates the surface area of the sediment basin to the outflow and critical particle settling velocity. The larger the sediment basin outflow, the larger the surface area required to settle the particle. As the outflow is reduced, a smaller surface area is required however the required storage volume dictates how small a surface area can become through the storage depth or hydraulic head acting on the outlet.

The particle settling velocities are listed in the standard requiring the designer to either start with a desired outflow based on an outlet size or an estimated starting surface area. The sample equation below starts with an estimated surface area.

#### Sample Problem:

A 10 acre site is being developed into condos. Eight acres of the site are being disturbed while 2 acres of forest are remaining undisturbed. The dominate soils on the site are silt loam. The 1-year, 24-hour design storm is 2.25 inches.

Step 1: Calculate runoff volume and peak using TR-55 or approved method.

From TR-55 the curve number (CN) for the disturbed area is 86 and the CN for the forested area is 55 resulting in a composite CN of 80. Using TR-55, the runoff volume calculated for the 1-year 24-hour design storm is 0.7 inches (0.6 acre-feet for the entire 10-acre site). The time of concentration was calculated as 0.4 hours resulting in a peak flow of 6 cfs.

Step 2: Begin sizing sediment basin using Equation 1. The technical standard lists silt loam under particle class 2 with a settling velocity of  $7.3 \times 10^{-5}$  ft/sec. We are also going to assume a starting surface area of 0.25 acres (10,890 ft<sup>2</sup>). An alternative approach is to assume an outflow velocity.

$$SA = 1.2 * (q_{out} / v_s)$$

$$\text{Solve for } q_{out}: 10,980 \text{ ft}^2 = 1.2 * (q_{out} / 7.3 \times 10^{-5} \text{ ft/sec})$$

$$q_{out} = 0.67 \text{ cfs}$$

Step 3: Using Figure 2: Approximate Detention Basin Routing for Type II Storms determines the volume of storage (V<sub>S</sub>) needed.

$$q_{out} = 0.67 \text{ cfs (calculated in Step 2)}$$

$$q_{in} = 6.0 \text{ cfs (peak flow calculated using TR-55 in Step 1)}$$

$$V_R = 0.6 \text{ acre-feet (volume of runoff calculated using TR-55 in Step 1)}$$

$$q_{out} / q_{in} = 0.67 \text{ cfs} / 6.0 \text{ cfs} = 0.11. \text{ Using Figure 2 with a } q_{out} / q_{in} = 0.11, \text{ the } V_S / V_R \text{ is determined to be 0.54. Therefore the } V_S = 0.54 * 0.6 \text{ acre-feet} = 0.324 \text{ acre-feet (14,113 ft}^3\text{)}$$

Step 4: Check configuration: Calculate maximum head on outlet using surface area and volume.

$$SA = 10,890 \text{ ft}^2 \text{ and a } V_S = 14,113 \text{ ft}^3 \text{ we get a depth (H) of } 1.29 \text{ feet} = 14,113 \text{ ft}^3 / 10,890 \text{ ft}^2$$

Step 5: Size Outlet: Assuming an orifice type outlet calculate the size needed to meet the q<sub>out</sub> calculated in Step 1 and the H calculated in Step 4.

Using the orifice equation:  $q_{out} = C * A * (2gH)^{1/2}$  with C=0.6 (coefficient), A = Area = ft<sup>2</sup>, g = 32.2, and H = hydraulic head expressed in feet.

$$q_{out} = 0.6 * A * (2 * 32.2 * H)^{1/2} \text{ so } 0.66 = 0.6 * A * (2 * 32.2 * 1.29)^{1/2} \text{ therefore } A = .12 \text{ ft}^2$$

An area of 0.12 ft<sup>2</sup> corresponds to an orifice outlet of 4.7 inches in diameter.

Step 6: Iteration: While the above solution works, the sediment basin has not been optimally sized and we have an orifice diameter that is not a standard pipe size. An iterative approach can be used to reduce the surface area of the sediment basin and obtain a more common orifice diameter. We can assume a 4-inch orifice since it is close to diameter calculated in Step 5 and we can start with the depth we calculated in Step 4. The iterations below each represent Steps 2 through 5.

#### Iteration 1:

$q_{out} = 0.43 (H)^{1/2} = 0.43 (1.29)^{1/2} = 0.48 \text{ cfs}$  which is less than the 0.66 cfs calculated in Step 1. Therefore, we can go back to Step 1 and repeat the sizing procedure and downsize the sediment basin.

$$SA = 1.2 * (q_{out} / v_s) = 1.2 * (0.48 \text{ cfs} / 7.3 * 10^{-5} \text{ ft/sec}) = 7,890 \text{ ft}^2$$

Using Figure 2:

$$q_{out} = 0.48 \text{ cfs}$$

$$q_{in} = 6.0 \text{ cfs (peak flow calculated using TR-55 in Step 1)}$$

$$V_R = 0.6 \text{ acre-feet (volume of runoff calculated using TR-55 in Step 1)}$$

$q_{out} / q_{in} = 0.48 \text{ cfs} / 6.0 \text{ cfs} = 0.08$ . Using Figure 2 with a  $q_{out} / q_{in} = 0.08$ , the  $V_S / V_R$  is determined to be 0.62. Therefore the  $V_S = 0.62 * 0.6 \text{ acre-feet} = 0.372 \text{ acre-feet} (16,204 \text{ ft}^3)$

$$SA = 7,890 \text{ ft}^2 \text{ and a } V_S = 16,204 \text{ ft}^3 \text{ we get a depth (H) of } 2.05 \text{ feet} = 16,204 \text{ ft}^3 / 7,890 \text{ ft}^2$$

$$q_{out} = 0.43 (H)^{1/2} = 0.43 (2.05)^{1/2} = 0.61 \text{ cfs which is more than the } 0.48 \text{ cfs we used so iterate.}$$

### Iteration 2:

$$SA = 1.2 * (q_{out} / v_s) = 1.2 * (0.61 \text{ cfs} / 7.3 * 10^{-5} \text{ ft/sec}) = 10,027 \text{ ft}^2$$

Using Figure 2:

$$q_{out} = 0.61 \text{ cfs}$$

$$q_{in} = 6.0 \text{ cfs (peak flow calculated using TR-55 in Step 1)}$$

$$V_R = 0.6 \text{ acre-feet (volume of runoff calculated using TR-55 in Step 1)}$$

$q_{out} / q_{in} = 0.61 \text{ cfs} / 6.0 \text{ cfs} = 0.10$  Using Figure 2 with a  $q_{out} / q_{in} = 0.10$ , the  $V_S / V_R$  is determined to be 0.54. Therefore the  $V_S = 0.54 * 0.6 \text{ acre-feet} = 0.324 \text{ acre-feet} (14,113 \text{ ft}^3)$

$$SA = 10,027 \text{ ft}^2 \text{ and a } V_S = 14,113 \text{ ft}^3 \text{ we get a depth (H) of } 1.41 \text{ feet} = 14,113 \text{ ft}^3 / 10,027 \text{ ft}^2$$

$$q_{out} = 0.43 (H)^{1/2} = 0.43 (1.41)^{1/2} = 0.51 \text{ cfs which is less than the } 0.61 \text{ cfs we used so we are OK or we can iterate again until we have } q_{out} \text{ that are almost identical.}$$

After Iteration 2, we have a sediment basin with a  $SA = 10,027 \text{ ft}^2$  and a  $V_S = 14,113 \text{ ft}^3$ . We have a principal water quality outlet consisting of a 4-inch orifice. This design meets the water quality requirements of the technical standard.

## Sediment Trap

1063 (09/05)

Wisconsin Department of Natural Resources

Conservation Practice Standard

### I. Definition

A *temporary*<sup>1</sup> sediment control device formed by excavation and/or embankment to intercept sediment-laden runoff and to retain the sediment.

### II. Purposes

To detain sediment-laden runoff from disturbed areas for sufficient time to allow the majority of the sediment to settle out.

### III. Conditions Where Practice Applies

Sediment traps are utilized in areas of concentrated flow or points of discharge during construction activities. Sediment traps shall be constructed at locations accessible for clean out. Sediment traps are designed to be in place until the contributory drainage area has been *stabilized*. The contributory drainage area shall be a maximum of 5 acres. For concentrated flow areas smaller than one acre, ditch checks may be installed; refer to WDNR conservation practice standard Ditch Check (1062). For larger drainage areas and/or for sediment basins requiring an engineered outlet structure refer to WDNR conservation practice standard Sediment Basin (1064) or Wet Detention Basin (1001).

### IV. Federal, State, and Local Laws

Users of this standard shall be aware of applicable federal, state, and local laws, rules, regulations, or permit requirements governing the use and placement of sediment traps. This standard does not contain the text of federal, state, or local laws.

### V. Criteria

This section establishes the minimum standards for design, installation and performance requirements.

- A. **Timing** – Sediment traps shall be constructed prior to disturbance of up-slope areas and placed so they function during all phases of construction. Sediment traps shall be placed in locations where runoff from disturbed areas can be diverted into the traps.
- B. **Sizing Criteria** – Properly sized sediment traps are relatively effective at trapping medium and coarse-grained particles. To effectively trap fine-grained particles, the sediment trap must employ a large surface area or polymers. The specific trapping efficiency of a sediment trap varies based on the surface area, depth of dead storage, and the particle size distribution and concentration of sediment entering the device.
  1. **Surface Area** – The minimum surface area of a sediment trap shall be based on the dominant textural class of the soil entering the device. The surface area calculated below represents the surface for the permanent pool area (if wet) or the surface area for the dead storage. This surface area is measured at the invert of the stone outlet (see Figure 1).
    - a. For coarse textured soils (loamy sand, sandy loam, and sand):
 
$$A_s \text{ (coarse)} = 625 * A_{dr}$$
    - b. For medium textured soils (loams, silt loams, and silt):
 
$$A_s \text{ (medium)} = 1560 * A_{dr}$$
    - c. For fine textured soils (sandy clay, silty clay, silty clay loam, clay loam, and clay):
 
$$A_s \text{ (fine)} = 5300 * A_{dr}$$

For the equations above:

$A_s$  = surface area of storage volume in square feet

$A_{dr}$  = contributory drainage area in acres

**Note:** The equations above were derived using a representative particle distribution for detached sediment for each textural class.

Sediment traps designed based on this standard will achieve 80% reduction of suspended solids for the drainage area.

- d. The surface area of sediment traps used in areas with fine to medium sized soils can be reduced when used in conjunction with water applied polymers. When employing polymers, size the surface area for controlling fine particles using the criteria for medium soils (V.B.1.b.) and when controlling medium sized particles use the sizing equation contained in (V.B.1.a.) for coarse soils. See WDNR Conservation Practice Standard Sediment Control Water Application of Polymers (1051) for criteria governing the proper use and selection of polymers.
2. **Depth** – The depth of the sediment trap measured from the sediment trap bottom to the invert of the stone outlet, shall be at least three feet to minimize re-suspension and provide storage for sediment.
3. **Shape** – The sediment trap shall have a length to width ratio of at least 2:1. The position of the outlet to the inlet shall be as such to minimize short-circuiting of the water flow path.
4. **Side Slopes** – Side slopes shall be no steeper than 2:1.

**Note:** A sediment trap sized with the surface area equations above, a three-foot depth, and 2:1 side slopes will generally result in an 80% sediment reduction. Slopes flatter than 2:1 will require larger surface areas to provide adequate storage.

- C. **Embankment** – Embankments of temporary sediment traps shall not exceed five feet in height measured from the downstream toe of the embankment to the top of the embankment. Construct embankments with a minimum top width of four feet, and side slopes of 2:1 or flatter. Earthen embankments shall be compacted. Where sediment traps are employed as a perimeter control, the embankments shall have stabilization practices place prior to receiving runoff.
- D. **Outlet** – Sediment traps shall be constructed with both a principal and emergency spillway. The stone outlet of a sediment trap shall consist of a stone section of embankment (stone outlet) located at the discharge point. The stone outlet section provides a means of dewatering the basin back to the top of the permanent storage between storm events, and also serves as a non-erosive emergency spillway for larger flow events.
  1. **Outlet Size** – The size of the outlet shall depend on the contributory drainage area and desired outflow. The length of the stone outlet / weir outlet can be calculated based on the size of the drainage area found in Table 1. Refer to section IX References for the equation used to calculate flow through a stone outlet or gabion.

**Table 1 Weir Length**

Drainage Area (acres)	Weir Length (feet)
1	4.0
2	6.0
3	8.0
4	10.0
5	12.0

The emergency spillway (top of the weir) shall be sized to adequately pass the 10-year 24-hour storm without over topping the sediment trap. The crest of the spillway shall be at least one foot below the top of the embankment. The, minimum weir lengths provided in Table 1 are adequate to pass the 10 year event.

**Note:** The weir length has little effect on overall treatment efficiency provided the sizing criteria in Section V.B. is adhered to. The stone outlet shall have a minimum top width of 2 feet and a maximum side-slope of 2:1. Discharge from the sediment basin shall be safely conveyed to a stormwater facility, drainage way, or waterbody. The discharge velocity shall be below the velocity to initiate scour unless appropriate stabilization methods are employed.

2. **Stone Size** – Stone shall consist of angular well graded 3 to 6 inch clear washed stone.
  3. **Keyway Trench** – The stone outlet shall be protected from undercutting by excavating a keyway trench across the stone foundation and up the sides to the height of the outlet. See Figure 1. Underlying with geotextile fabric is optional.
- E. Provide access for cleanout and disposal of trapped sediment.

## VI Considerations

- A. Sediment traps generally require excessive surface areas to settle clay particles and fine silts. If these conditions exist on the site consider using a sediment basin (DNR Conservation Practice Standard Sediment Basin 1064) or adding polymer to the sediment trap. See WDNR Conservation Practice Standard Sediment Control Water Application of Polymers (1051) for criteria governing the use of polymers

- B. To improve trapping efficiency, filter fabric can be placed on the up-slope side of the stone outlet / gabion and anchored with stone. When fabric is utilized to enhance filtering, more frequent maintenance is required to prevent clogging. When using fabric, a monofilament type fabric shall be used (such as WisDOT Type FF). The apparent opening size of the fabric, not the stone size, will dictate the flow rate through the outlet therefore outlet lengths need to be calculated since values in Table 1 are based on stone. When calculating the size of the outlet a clogging factor of 50% should be used for the fabric.
- C. Consider possible interference with construction activities when locating sediment traps.
- D. Provisions should be made for protecting the embankment from failure caused by storms exceeding the 10-year design requirement. Consider a stabilized and non-erosive emergency spillway bypass.
- E. In general, groundwater impacts from temporary sediment traps that have storage areas in contact with groundwater are not a major concern. However, sediment trap contact with groundwater should be avoided in areas with karst features, fractured bedrock, or areas of significant groundwater recharge.
- F. Sediment trapping is achieved primarily by settling within the pool formed by the trap. Sediment trapping efficiency is a function of surface area, depth of pool, and detention time. If site conditions permit, a length to width ratio greater than 2:1 will increase efficiency.
- G. If site conditions prevent the sediment trap from having a three-foot depth, then an equivalent storage volume must be created through increasing the surface area.
- H. For sediment traps in place longer than 6 months, consider outlets constructed of two types of stone. A combination of coarse aggregate and riprap (WisDOT light riprap classification) should be used to provide stability. A one-foot layer of one inch washed stone then should be placed on the up-slope face to reduce drainage flow rate.

## VII Plans and Specifications

- A. Plans and specifications for installing sediment traps shall be in keeping with this standard and shall describe the requirements for applying the practice to achieve its intended purpose. The plans and specifications shall address the following:
  1. Location and spacing of sediment traps
  2. Schedules and sequence of installation and removal
  3. Standard drawings and installation details
  4. Rock gradation
- B. All plans, standard detail drawings, or specifications shall include a schedule for installation, inspection, maintenance, and identify the responsible party.

## VIII Operation and Maintenance

Sediment Traps shall, at a minimum, be inspected weekly and within 24 hours after every precipitation event that produces 0.5 inches of rain or more during a 24-hour period. Sediment may need to be removed more frequently.

- A. Deposits of sediment shall be removed when they reach a depth of one foot.
- B. If the outlet becomes clogged it shall be cleaned to restore flow capacity.
- C. Recommend provisions for proper disposal of the sediment removed from the trap.
- D. Maintenance shall be completed as soon as possible with consideration given to site conditions.
- E. Sediment traps shall be removed and the location stabilized after the disturbed area draining to the sediment trap is stabilized and no longer susceptible to erosion.

## IX References

Flow through the stone outlet and gabion can be calculated using the following equation:

$$Q = (h^{2/3} * L) / [(W/D) + 25 + W^2]^{1/2}$$

Where:

Q = total flow through stone (cfs)

$h$  = depth of flow measured from invert of the stone outlet to the crest of emergency spillway (ft)

$W$  = average width of weir or flow

length through stone outlet (ft)

$L$  = length of weir (ft)

$D$  = Average Rock Diameter (ft)

**Note:** For a stone outlet, the length of stone outlet ( $L$ ) will vary with the depth and slope of stone outlet. For a gabion, the length of flow is fixed to gabion width. A complete discussion of this equation and its proper application can be found in:

C. McIntyre, G. Aron, J. Willenbrock, and M. Deimler. Report No. 10: Analysis of flow through porous media as applied to gabion dams regarding the storage and release of storm water runoff. NAHB/NRC Designated Housing Research Center at Penn State, Department of Civil Engineering; August 1992.

## **X Definitions**

*Stabilized (III):* Means that all land disturbing construction activities at the construction site have been completed and that a uniform perennial vegetative cover has been established with a density of at least 70% of the cover for the unpaved areas and areas not covered by permanent structures or that employ equivalent stabilization measures.

*Temporary (I):* An erosion control measure that is in place for the duration of construction or until the site is stabilized.

**Figure 1: Sediment Trap Outlet Detail**

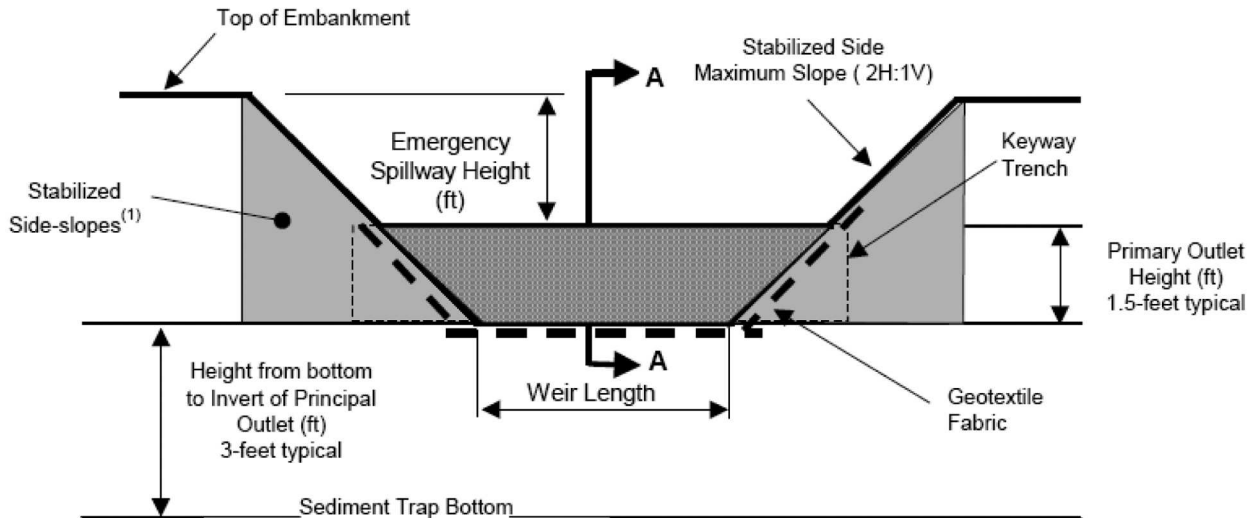

**Cross-section View of Principal Outlet**

Notes: (1) Side-slopes and faces of earthen embankment around outlet shall be armored with riprap or stabilized with erosion mat sufficient to handle flows from the 10-year storm.

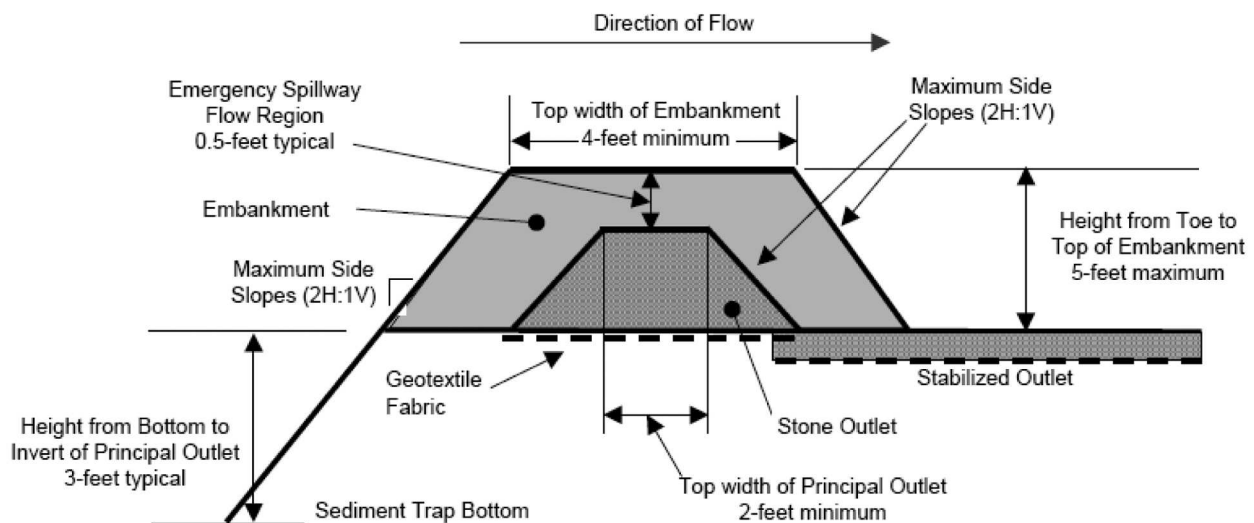

**View A - A of Principal Outlet**

## Seeding For Construction Site Erosion Control

1059 (11/03)

Wisconsin Department of Natural Resources

Conservation Practice Standard

**Note:** Words in the standard that are shown in italics are described in X. Definitions. The words are italicized the first time they are used.

### I. Definition

Planting seed to establish temporary or permanent vegetation for erosion control.

### II. Purpose

The purpose of *temporary seeding*<sup>1</sup> is to reduce runoff and erosion until permanent vegetation or other erosion control practices can be established. The purpose of *permanent seeding* is to permanently stabilize areas of exposed soil.

### III. Conditions Where Practice Applies

This practice applies to areas of exposed soil where the establishment of vegetation is desired. Temporary seeding applies to disturbed areas that will not be brought to final grade or on which land-disturbing activities will not be performed for a period greater than 30 days, and requires vegetative cover for less than one year. Permanent seeding applies to areas where perennial vegetative cover is needed.

### IV. Federal, State and Local Laws

Users of this standard shall be aware of all applicable federal, state and local laws, rules, regulations or permit requirements governing seeding. This standard does not contain the text of federal, state or local laws.

### V. Criteria

This section establishes the minimum standards for design, installation and performance requirements.

#### A. Site and Seedbed Preparation

Site preparation activities shall include:

##### 1. Temporary Seeding

- a. Temporary seeding requires a seedbed of loose soil to a minimum depth of 2 inches.
- b. Fertilizer application is not generally required for temporary seeding. However, any application of fertilizer or lime shall be based on soil testing results.
- c. The soil shall have a pH range of 5.5 to 8.0.

##### 2. Permanent Seeding

- a. Topsoil installation shall be completed prior to permanent seeding.
- b. Permanent seeding requires a seedbed of loose topsoil to a minimum depth of 4 inches with the ability to support a *dense* vegetative cover.
- c. Application rates of fertilizer or lime shall be based on soil testing results.
- d. Prepare a tilled, fine, but firm seedbed. Remove rocks, twigs foreign material and clods over two inches that cannot be broken down.
- e. The soil shall have a pH range of 5.5 to 8.0.

#### B. Seeding

##### 1. Seed Selection

- a. Seed mixtures that will produce dense vegetation shall be selected based on soil and site conditions and intended final use. Section IX References, lists sources containing suggested seed mixtures.
- b. All seed shall conform to the requirements of the Wisconsin Statutes and of the Administrative Code Chapter [ATCP 20.01](#) regarding noxious weed seed content and labeling.

- c. Seed mixtures that contain potentially invasive species or species that may be harmful to native plant communities shall be avoided.
- d. Seed shall not be used later than one year after the test date that appears on the label.
- e. Seed shall be tested for purity, germination and noxious weed seed content and shall meet the minimum purity and germination requirements as prescribed in the current edition of Rules for Testing Seed, published by the Association of Official Seed Analysts.

## 2. Seed Rates

### a. Temporary Seeding (Cover Crop)

Areas needing protection during periods when permanent seeding is not applied shall be seeded with annual species for temporary protection. See Table 1 for seeding rates of commonly used species. The residue from this crop may either be incorporated into the soil during seedbed preparation at the next permanent seeding period or left on the soil surface and the planting made as a no-till seeding.

**Table 1**  
**Temporary Seeding Species and Rates**

Species	Lbs/Acre	Percent Purity
Oats	131 <sup>1</sup>	98
Cereal Rye	131 <sup>2</sup>	97
Winter wheat	131 <sup>2</sup>	95
Annual Ryegrass	80 <sup>2</sup>	97

1 Spring and summer seeding

2 Fall seeding

### b. Permanent Seeding

Rates shall be based on pounds or ounces of Pure Live Seed (PLS) per acre. Section IX contains some possible reference documents that provide seeding rates. Permanent seeding rates may be increased above the minimum rates shown in the reference documents to address land use and environmental conditions.

If a *nurse crop* is used in conjunction with permanent seeding, the nurse crop shall not hinder establishment of the permanent vegetation.

A nurse crop shall be applied at 50% its temporary seeding rate when applied with permanent seed.

## 3. Inoculation

Legume seed shall be inoculated in accordance with the manufacturer's recommendations. Inoculants shall not be mixed with liquid fertilizer.

## 4. Sowing

Seed grasses and legumes no more than ¼ inch deep. Distribute seed uniformly. Mixtures with low seeding rates require special care in sowing to achieve proper seed distribution.

Seed may be broadcast, drilled, or hydroseeded as appropriate for the site.

Seed when soil temperatures remain consistently above 53° F. *Dormant seed* when the soil temperature is consistently below 53° F (typically Nov. 1st until snow cover). Seed shall not be applied on top of snow.

## VI. Considerations

- A. Consider seeding at a lower rate and making two passes to ensure adequate coverage.
- B. Compacted soil areas may need special site preparation prior to seeding to mitigate compaction. This may be accomplished by chisel plowing to a depth of 12 inches along the contour after heavy equipment has left the site.
- C. Sod may be considered where adequate watering is available.
- D. When working in riparian areas refer to the NRCS Engineering Field Handbook, Chapter 16, Streambank and Shoreline Protection and Chapter 18, *Soil Bioengineering* for Upland Slope Protection and Erosion Reduction.

- E. A site assessment should be conducted to evaluate soil characteristics, topography, exposure to sunlight, proximity to natural plant communities, proximity to nuisance, noxious and/or invasive species, site history, moisture regime, climatic patterns, soil fertility, and previous herbicide applications.
- F. Use *introduced species* only in places where they will not spread into existing natural areas.
- G. Lightly roll or compact the area using suitable equipment when the seedbed is judged to be too loose, or if the seedbed contains clods that might reduce seed germination.
- H. See Section IX. References for suggested seed mixes (NRCS, WisDOT, UWEX) or use their equivalent.
- I. Turf seedlings should not be mowed until the stand is at least 6 inches tall. Do not mow closer than 3 inches during the first year of establishment.
- J. Seeding should not be done when the soil is too wet.
- K. Consider watering to help establish the seed. Water application rates shall be controlled to prevent runoff and erosion.
- L. Prairie plants may not effectively provide erosion control during their establishment period without a nurse crop.
- M. Topsoil originating from agricultural fields may contain residual chemicals. The seedbed should be free of residual herbicide or other contaminants that will prevent establishment and maintenance of vegetation. Testing for soil contaminants may be appropriate if there is doubt concerning the soil's quality.
- N. Consider using mulch or a nurse crop if selected species are not intended for quick germination. When mulching refer to WDNR Conservation Practice Standard Mulching for Construction Sites (1058).

## VII. Plans and Specifications

Plans and specifications for seeding shall be in keeping with this standard and shall describe the requirements for applying this practice.

All plans, standard detail drawings, or specifications shall include schedule for installation, inspection, and maintenance. The responsible party shall be identified.

## VIII. Operation and Maintenance

- A. During construction areas that have been seeded shall at a minimum be inspected weekly and within 24 hours after every precipitation event that produces 0.5 inches of rain or more during a 24-hour period. Inspect weekly during the growing season until vegetation is densely established or permit expires. Repair and reseed areas that have erosion damage as necessary.
- B. Limit vehicle traffic and other forms of compaction in areas that are seeded.
- C. A fertilizer program should begin with a soil test. Soil tests provide specific fertilizer recommendations for the site and can help to avoid over-application of fertilizers.

## IX. References

### A. Seed Selection References

United States Department of Agriculture – Natural Resource Conservation Service Field Office Technical Guide Section IV, Standard 342, Critical Area Planting.

UWEX Publication A3434 Lawn and Establishment & Renovation.

WisDOT, 2003. State of Wisconsin Standard Specifications For Highway and Structure Construction. Section 630, Seeding.

### B. General References

Association of Official Seed Analysts, 2003. Rules for Testing Seed. <http://www.aosaseed.com>.

Metropolitan Council, 2003. Urban Small Sites Best Management Practice Manual, Chapter 3, Vegetative Methods 3–85 – 3–91. Minneapolis.

The State of Wisconsin list of noxious weeds can be found in Statute 66.0407.

United States Department of Agriculture – Natural Resources Conservation Service. Engineering Field Handbook, Chapters 16 and 18.

UWEX Publication GWQ002 Lawn & Garden Fertilizers.

## X. Definitions

*Dense* (V.A.2.b) A stand of 3–inch high grassy vegetation that uniformly covers at least 70% of a representative 1 square yard plot.

*Dormant seed* (V.B.4): Seed is applied after climatic conditions prevent germination until the following spring.

*Introduced Species* (VI.F) Plant species that historically would not have been found in North America until they were brought here by travelers from other parts of the world. This would include smooth brome grass and alfalfa. Some of these species may have a wide distribution such as Kentucky bluegrass.

*Nurse Crop* (V.B.2.b): Also known as a companion crop; is the application of temporary (annual) seed with permanent seed.

*Permanent seeding* (II) Seeding designed to minimize erosion for an indefinite period after land disturbing construction activities have ceased on the site.

*Soil Bioengineering* (VI.D) Practice of combining mechanical, biological and ecological concepts to arrest and prevent shallow slope failures and erosion.

*Temporary Seeding* (II) Seeding designed to control erosion for a time period of one year or less that is generally removed in order to perform further construction activities or to permanently stabilize a construction site.

*Topsoil* (V.A.2.a) Consists of loam, sandy loam, silt loam, silty clay or clay loam humus-bearing soils adapted to sustain plant life with a pH range of 5.5 – 8.0. Manufactured topsoil shall through the addition of sand or organic humus material, peat, manure or compost meet the above criteria.

## Silt Fence

1056 (03/06)

### Wisconsin Department of Natural Resources Conservation Practice Standard

**Note:** Words in the standard that are shown in italics are described in X. Definitions. The words are italicized the first time they are used.

#### I. Definition

Silt fence is a temporary sediment barrier of entrenched permeable geotextile fabric designed to intercept and slow the flow of sediment-laden sheet flow runoff from small areas of disturbed soil.

#### II. Purpose

The purpose of this practice is to reduce slope length of the disturbed area and to intercept and retain transported sediment from disturbed areas.

#### III. Conditions Where Practice Applies

- A. This standard applies to the following applications:
1. Erosion occurs in the form of *sheet and rill erosion*<sup>1</sup>. There is no concentration of water flowing to the barrier (*channel erosion*).
  2. Where adjacent areas need protection from sediment-laden runoff.
  3. Where effectiveness is required for one year or less.
  4. Where conditions allow for silt fence to be properly entrenched and staked as outlined in the Criteria Section V.
- B. Under no circumstance shall silt fence be used in the following applications:
1. Below the ordinary high watermark or placed perpendicular to flow in streams, swales, ditches or any place where flow is concentrated.
  2. Where the maximum gradient upslope of the fence is greater than 50% (2:1).

#### IV. Federal, State, and Local Laws

Users of this standard shall be aware of applicable federal, state, and local laws, rules, regulations, or permit requirements governing the use and placement of silt fence. This standard does not contain the text of federal, state, or local laws.

#### V. Criteria

This section establishes the minimum standards for design, installation and performance requirements.

- A. Placement
1. When installed as a stand-alone practice on a slope, silt fence shall be placed on the contour. The parallel spacing shall not exceed the maximum slope lengths for the appropriate slope as specified in Table 1.

**Table 1**

Slope	Fence Spacing
< 2%	100 feet
2 to 5%	75 feet
5 to 10%	50 feet
10 to 33%	25 feet
> 33%	20 feet

2. Silt fences shall not be placed perpendicular to the contour.
3. The ends of the fence shall be extended upslope to prevent water from flowing around the ends of the fence.

- B. Height – Installed silt fences shall be a minimum 14 inches high and shall not exceed 28 inches in height measured from the installed ground elevation.
- C. Support – Silt fences shall be supported by either steel or wood supports as specified below:
1. Wood supports
    - a. The full height of the silt fence shall be supported by 1 1/8 inches by 1 1/8 inches air or kiln dried posts of hickory or oak.
    - b. The silt fence fabric shall be stapled, using at least 0.5–inch staples, to the upslope side of the posts in at least 3 places.
    - c. The posts shall be a minimum of 3 feet long for 24–inch silt fence and a minimum of 4 feet for 36–inch silt fence fabric.
  2. Steel supports
    - a. The full height of the silt fence shall be supported by steel posts at least 5 feet long with a strength of 1.33 pounds per foot and have projections for the attachment of fasteners.
    - b. The silt fence fabric shall be attached in at least three places on the upslope side with 50 pound plastic tie straps or wire fasteners. To prevent damage to the fabric from fastener, the protruding ends shall be pointed away from the fabric.
  3. The maximum spacing of posts for non–woven silt fence shall be 3 feet and for woven fabric 8 feet.
  4. Silt fence shall have a support cord.
  5. Where joints are necessary, each end of the fabric shall be securely fastened to a post. The posts shall then be wrapped around each other to produce a stable, secure joint or shall be overlapped the distance between two posts.
  6. A minimum of 20 inches of the post shall extend into the ground after installation.
- D. Anchoring – Silt fence shall be anchored by spreading at least 8 inches of the fabric in a 4 inch wide by 6 inch deep trench, or 6 inch deep V–trench on the upslope side of the fence. The trench shall be backfilled and compacted. Trenches shall not be excavated wider and deeper than necessary for proper installation.
- On the terminal ends of silt fence the fabric shall be wrapped around the post such that the staples are not visible.
- E. Geotextile Fabric Specifications – The geotextile fabric consists of either woven or non–woven polyester, polypropylene, stabilized nylon, polyethylene, or polyvinylidene chloride. Non–woven fabric may be needle punched, heat bonded, resin bonded, or combinations thereof. All fabric shall meet the following requirements as specified in Table 2.

Table 2

Test Requirement	Method	Value <sup>1</sup>
Minimum grab tensile strength in the machine direction	ASTM D 4632	120 lbs. (550 N)
Minimum grab tensile strength in the cross machine direction	ASTM D 4632	100 lbs. (450 N)
Maximum apparent opening size equivalent standard sieve	ASTM D 4751	No. 30 (600 µm)
Minimum permittivity	ASTM D 4491	0.05 scc <sup>-1</sup>
Minimum ultraviolet stability percent of strength retained after 500 hours of exposure	ASTM D 4355	70%

(WisDOT Standard Specifications for Road and Bridge Construction, 2001)

<sup>1</sup> All numerical values represent minimum / maximum average roll values. (For example, the average minimum test results on any roll in a lot should meet or exceed the minimum specified values.)

Silt fence shall have a maximum flow rate of 10–gallons/minute/square foot at 50mm constant head as determined by multiplying permittivity in 1/second as determined by ASTM D–4491 by a conversion factor of 74.

- F. Removal – Silt fences shall be removed once the disturbed area is permanently stabilized and no longer susceptible to erosion.

**VI. Considerations**

- A. Improper placement as well as improper installation and maintenance of silt fences will significantly decrease the effectiveness of this practice.

Silt fences should be considered for trapping sediment where sheet and rill erosion may be expected to occur in small drainage areas. Silt fences should not be placed in areas of concentrated flow.

- B. Silt fences should be installed prior to disturbing the upslope area.
- C. Silt fences should not be used to define the boundaries of the entire project. Silt fence should be placed only in areas where it is applicable due to its cost and the fact that it is not biodegradable. For example, silt fence should not be placed in locations where the natural overland flow is from an undisturbed area into disturbed areas of the project. It should also not be used as a diversion.
- D. Silt fence should not be used in areas where the silt fence is at a higher elevation than the disturbed area.
- E. When placing silt fence near trees, care should be taken to minimize damage to the root system. Avoid compaction and root cutting within 1.5 feet multiplied by the inch diameter of the tree (for example: for 10-inch trees keep out a 15-foot radius from the trunk). Refer to UWEX publication Preserving Trees During Construction for more information.
- F. To protect silt fence from damage in areas of active construction or heavy traffic, silt fence should be flagged, marked, or highlighted to improve visibility.
- G. Silt fence effectiveness is generally increased when used in conjunction with other upslope erosion control practices. To further strengthen the silt fence, straw / hay bales can be placed on the down slope side.
- H. To help ensure effectiveness, silt fence should be inspected and repaired as necessary prior to forecasted rain events.
- I. Where installation with wood posts is difficult, such as when hard or frozen ground is encountered, the use of steel post is recommended.
- J. Silt fence can be mechanically installed with a plow type device provided that the silt fence is trenched in a manner such that equivalent performance is achieved to that specified in Section V.D.

**VII. Plans and Specifications**

- A. Plans and specifications for installing silt fence shall be in keeping with this standard and shall describe the requirements for applying the practice to achieve its intended purpose. The plans and specifications shall address the following:
  1. Location of silt fence
  2. Contributory drainage area
  3. Schedules
  4. Material specification conforming to standard
  5. Standard drawings and installation details
  6. Restoration after removal
- B. All plans, standard detail drawings, or specifications shall include schedule for installation, inspection, and maintenance. The responsible party shall be identified.

**VIII. Operation and Maintenance**

- A. Silt fences shall at a minimum be inspected weekly and within 24 hours after every precipitation event that produces 0.5 inches of rain or more during a 24 hour period.
- B. Damaged or decomposed fences, undercutting, or flow channels around the end of barriers shall be repaired or corrected.
- C. Sediment shall be properly disposed of once the deposits reach ½ the height of the fence.

## **IX. References**

UWEX Publication A0327 “Preserving Trees During Construction”

## **X. Definitions**

*Channel Erosion* (III.A.1): The deepening and widening of a channel due to soil loss caused by flowing water. As rills become larger and flows begin to concentrate, soil detachment occurs primarily as a result of shear.

*Sheet and Rill Erosion* (III.A.1): Sheet and rill erosion is the removal of soil by the action of rainfall and shallow overland runoff. It is the first stage in water erosion. As flow becomes more concentrated rills occur. As soil detachment continues or flow increases, rills will become wider and deeper forming gullies.

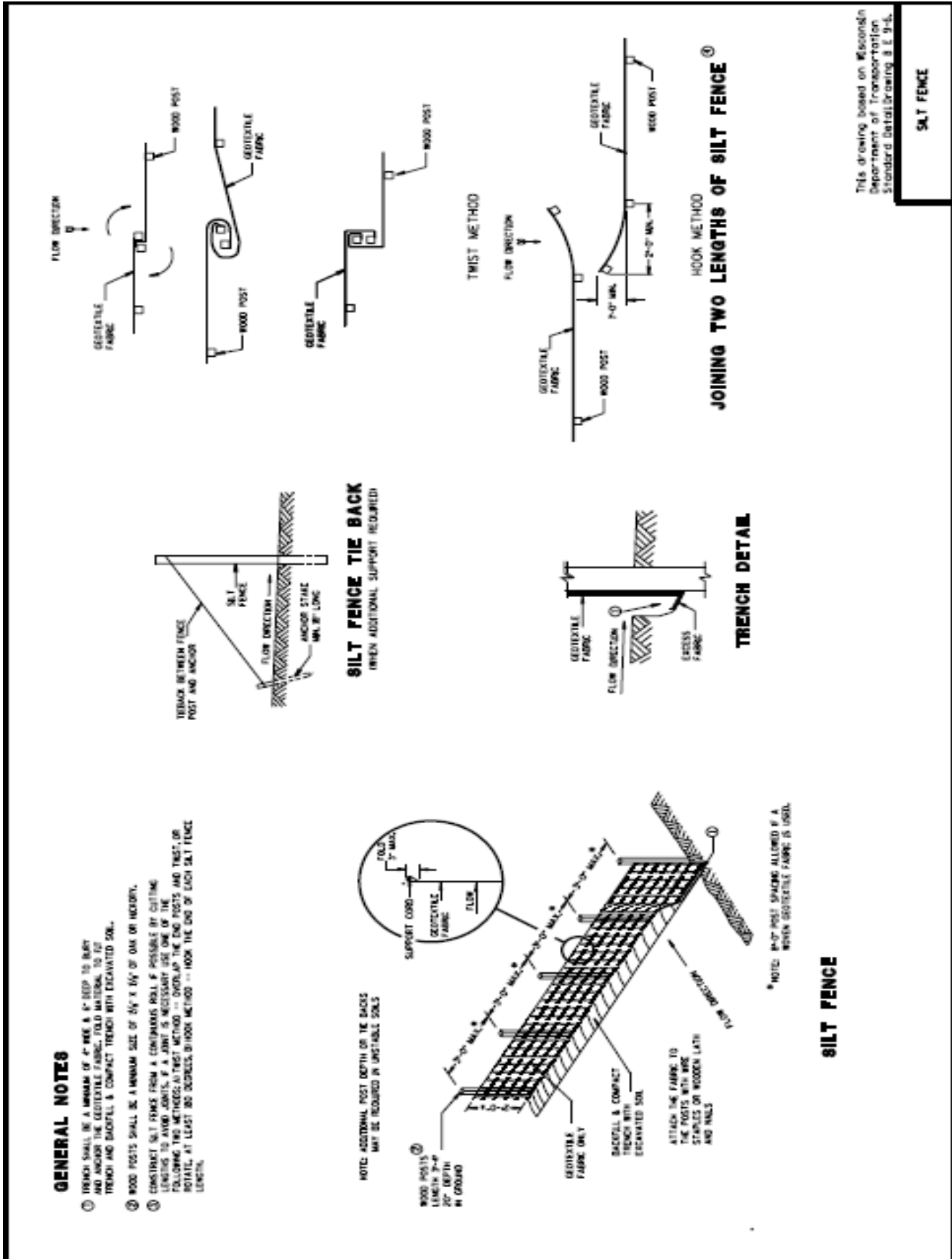

**Silt Curtain****1070 (09/05)**

## Wisconsin Department of Natural Resources

## Conservation Practice Standard

**Note:** Words in the standard that are shown in italics are described in X. Definitions. The words are italicized the first time they are used.

**I. Definition**

A temporary permeable fabric installed in a waterway or waterbody to minimize sediment transport. A silt curtain does not extend to the bottom of the channel and is placed parallel or perpendicular to the direction of flow.

**II. Purposes**

The purpose of this practice is to provide sediment containment while construction activities are occurring in or directly adjacent to a waterway or waterbody.

**III. Conditions Where Practice Applies**

This practice applies where construction activities intrude or are directly adjacent to a waterway or waterbody. This includes but is not limited to bridge construction, rip rap placement, utility work, streambank restoration, boat launches and dredging.

Silt curtain is intended for calm water conditions where it will not be subjected to wind, wave, or current. Silt curtains are appropriate to settle out coarse and granular soils where water depth at the time of construction is greater than or equal to 4 feet. For applications in finer sediment or moving water see WDNR Technical Standard 1069 Turbidity Barrier.

**IV. Federal, State, and Local Laws**

Users of this standard shall be aware of applicable federal, state, and local laws, rules, regulations, or permit requirements governing the use and placement of silt curtains. This standard does not contain the text of federal, state, or local laws.

**V. Criteria**

This section establishes the minimum standards for design, installation and performance requirements.

- A. Installation – Details of construction not listed in the text shall conform to the pertinent requirements of Figure 1.
  1. The silt curtain shall be installed before construction activities are initiated in or adjacent to the waterway or waterbody. Install the silt curtain as close to the construction as practical. The curtain shall remain in place and be maintained until the construction activity is completed and the disturbed area is *stabilized*<sup>1</sup>.
  2. The ends of the silt curtain shall be securely anchored and keyed into the shoreline to fully enclose the area where sediment may enter the water.
  3. A 2-foot gap shall exist between the weighted lower end of the curtain and the bottom of the waterway or waterbody.
  4. Bottom anchors shall be used to hold the silt curtain in the same position relative to the bottom the waterway or waterbody without interfering with the function of the curtain. Anchors shall either be driven into the bottom of the waterway or waterbody or be weighted and attached to the curtain floatation device via an anchor line. Manufacturer's recommendations shall be followed for the number and spacing of anchors.
  5. Danger buoys shall be used as directed by the Coast Guard or DNR permit when working in navigable waters.
- B. Material:
  1. Reusable components of the silt curtain system shall be clean and free of potential exotic species. Fabric cannot be reused.
  2. The silt curtain shall be constructed from heavy woven filter fabric to allow water to pass through the barrier yet retain sediment. All fabric seams shall be heat sealed or sewn. Silt curtain fabric shall conform to the specifications in Table 1.

Table 1

Requirement	Value
Thickness	15 mils (0.38 mm)
Min. grab tensile strength (ASTM D 4632)	120 lb (550 N)
Min. equivalent opening	No. 170 sieve (90 µm)

3. Flotation devices shall be flexible, buoyant units contained in an individual flotation sleeve or collar attached to the curtain. Use expanded polystyrene logs or equivalent having a 49 square inch minimum end area. Do not use polystyrene beads or chips. Buoyancy provided by the flotation device shall be sufficient to support the weight of the curtain and maintain a freeboard of at least 3 inches above the water surface level.
4. Top load lines shall consist of 5/16 inch steel cable.
5. Bottom load lines shall consist of a minimum ¼-inch steel chain incorporated into the bottom hem of the curtain. Larger chain sizes may be used where additional weight to serve as ballast to hold the curtain in a vertical position is required.

## VI. Considerations

- A. Sediment that has settled out by the silt curtain should only be removed as directed by the regulatory authority because re-suspension of sediment will likely occur during the removal process. Use of polymers may help prevent resuspension of sediment. See WDNR Technical Standard 1051 Sediment Control Water Application of Polymers for further guidance.
- B. Silt curtains are meant to manage sediment in the waterbody. The best way to prevent sediment from entering the waterbody is through the implementation of effective upland erosion control, stopping sediment transport at its source.

## VII. Plans and Specifications

Plans and specifications for installing a silt curtain shall be in keeping with this standard and shall describe the requirements for applying the practice to achieve its intended purpose:

- A. Location of silt curtain.
- B. Material specification conforming to standard.
- C. All plans, standard detail drawings, or specifications shall include schedule for installation, inspection, and maintenance. The responsible party shall be identified.

## VIII. Operation and Maintenance

- A. Silt curtains shall be inspected daily and repaired if necessary.
- B. Regardless of upland stabilization conditions silt curtains shall not be removed until the water behind the curtain has equal or greater clarity than the waterway or waterbody. Soil particles shall be allowed to settle for a minimum of 24 hours prior to removal of the curtain.
- C. Care shall be taken when removing the silt curtain to minimize the release or re-suspension of accumulated sediment.
- D. To prevent the spread of exotic species silt curtains shall not be reused on other sites. Buoys and chains can be reused but shall be either disinfected with vinegar or cleaned with hot water greater than 104 deg. F then allowed to completely dry for a minimum period of five days. If there are any questions about the occurrence of zebra mussels, Eurasian water-milfoil, or other aquatic invasive species in a waterbody that you are working in or intend to work in contact your local DNR staff.

## IX. References

Virginia Erosion and Sediment Control Handbook, Third Edition, 1992

WisDOT Facilities Development Manual: Chapter 10, Section 10, Subject 43, Silt Screen

## X. Definitions

*Stabilized* (V.A.1): Means that all land disturbing construction activities at the construction site have been completed, and that a uniform perennial vegetative cover has been established with a density of at least 70% of the cover for the unpaved areas and areas not covered by permanent structures, or that employ equivalent stabilization measures.

## Stone Tracking Pad and Tire Washing

1057 (08/03)

Wisconsin Department of Natural Resources

Conservation Practice Standard

**Note:** Words in the standard that are shown in italics are described in IX. Definitions. The words are italicized the first time they are used.

### I. Definition

A stabilized pad of stone aggregate or tire washing station located at any point where traffic will egress a construction site.

### II. Purpose

The purpose of this standard is to reduce off-site sedimentation by eliminating the tracking of sediment from construction sites.

### III. Conditions Where Practice Applies

Either a stone tracking pad or tire washing station shall be used at all points of construction egress. This standard applies where construction traffic is likely to transport sediment off site.

### IV. Federal, State, and Local Laws

Users of this standard shall be aware of applicable federal, state, and local laws, rules, regulations, or permit requirements governing the use and placement of this practice. This standard does not contain the text of federal, state, or local laws.

### V. Criteria

This section establishes the minimum standards for design, installation and performance requirements.

#### A. Tracking Pad:

1. The tracking pad shall be installed prior to any traffic leaving the site.
2. The aggregate for tracking pads shall be 3 to 6 inch clear or washed stone. All material to be retained on a 3-inch sieve.
3. The aggregate shall be placed in a layer at least 12 inches thick. On sites with a high water table, or where saturated conditions are expected during the life of the practice, stone tracking pads shall be underlain with a WisDOT Type R geotextile fabric to prevent migration of underlying soil into the stone.
4. The tracking pad shall be the full width of the egress point. The tracking pad shall be at a minimum 50 feet long.
5. Surface water must be prevented from passing through the tracking pad. Flows shall be diverted away from tracking pads or conveyed under and around them by using a variety of practices, such as culverts, *water bars*<sup>1</sup>, or other similar practices.

#### B. Tire washing: If conditions on the site are such that the sediment is not removed from vehicle tires by the tracking pad, then tires shall be washed utilizing pressurized water before entering a public road.

1. The washing station shall be located on-site in an area that is stabilized and drains into suitable sediment trapping or settling device.
2. The wash rack shall consist of a heavy grating over a lowered area. The rack shall be strong enough to support the vehicles that will cross it.

#### C. Rocks lodged between the tires of dual wheel vehicles shall be removed prior to leaving the construction site.

**VI. Considerations**

- A. Vehicles traveling across the tracking pad should maintain a slow constant speed.
- B. The best approach to preventing off-site tracking is to restrict vehicles to stabilized areas.
- C. It is always preferable to prevent sediment from being deposited upon the road than cleaning the road later. Sediment on a road can create a safety hazard as well as a pollution problem.
- D. Any sediment tracked onto a public or private road should be removed by street cleaning, not flushing, before the end of each working day.

**VII. Plans and Specifications**

- A. Plans and specifications for installing tracking pads shall be in keeping with this standard and shall describe the requirements for applying the practice to achieve its intended purpose. The plans and specifications shall address the following:
  - 1. Location of all points of egress with tracking pad locations shown
  - 2. Material specifications conforming to standard
  - 3. Schedule for installation and removal
  - 4. Standard drawings and installation details
  - 5. Stabilization after removal
- B. All plans, standard detail drawings, or specifications shall include schedule for installation, inspection, and maintenance. The responsible party shall be identified.

**VIII. Operation and Maintenance**

- A. Tracking pads and tire washing stations shall, at a minimum, be inspected weekly and within 24 hours after every precipitation event that produces 0.5 inches of rain or more during a 24-hour period.
- B. The tracking pad performance shall be maintained by scraping or top-dressing with additional aggregate.
- C. A minimum 12-inch thick pad shall be maintained.

**IX. Definitions**

*Water bar* (V.A.5): A shallow trench or diversion dam that diverts surface water runoff into a dispersion area.

## Storm Drain Inlet Protection For Construction Sites

**1060 (10/03)**

Wisconsin Department of Natural Resources

Conservation Practice Standard

### I. Definition

A temporary barrier installed around a storm drain inlet, drop inlet or curb inlet.

### II. Purposes

The purpose of this practice is to reduce sediment from entering storm drains before stabilizing the contributing drainage area.

### III. Conditions Where Practice Applies

This practice applies where runoff from construction sites enters conveyance system structures such as drain inlets, drop inlets, and curb inlets. Inlet protection devices are for drainage areas of one acre or less. Runoff from areas larger than one acre should be routed through a properly designed sediment trapping or settling practice upstream of the inlet.

### IV. Federal, State, and Local Laws

Users of this standard shall be aware of applicable federal, state, and local laws, rules, regulations, or permit requirements governing the use and placement of storm drain inlet protection. This standard does not contain the text of federal, state, or local laws.

### V. Design Criteria

This section establishes the minimum standards for design, installation and performance requirements.

The appropriate type of inlet protection barrier shall be installed once the drain, drop, or curb inlet can receive runoff. The device shall remain in place and be maintained until the disturbed area is stabilized.

#### A. General Criteria that is applicable to all inlet protection devices

1. Ponding water to settle sediment is encouraged; however ponding shall not interfere with the flow of traffic, create a safety hazard, or cause property damage. All devices shall have provisions such as weep holes or "emergency spillways" to safely pass water if the device becomes clogged.
2. The contributing drainage area to the inlet protection device shall be one acre or less. In instances where a larger contributing drainage area exists, runoff shall be routed through a properly designed sediment trapping or settling device upstream of inlet.
3. Other than Type D inlet protection devices, no gaps shall be left in the material used that would allow the flow of water to bypass the inlet protection device.
4. All fabrics used as part of an inlet protection device must be selected from the list of approved fabrics certified for inlet protection, Geotextile Fabric, Type FF in the current addition of the WisDOT Product Acceptability List (PAL).

#### B. Criteria Applicable to Unpaved areas or the Pre-Paving Phase of Construction

1. Inlet Protection Barriers include, but are not limited to, straw bales, sandbags, other material filled bags and socks, and stone weepers. These devices can be used to either settle sediments or divert flows.
  - a. Manufactured bags, when used, shall conform to the standards in Table 1.

Table 1

Minimum Size	14 x 26 inches
Grab Tensile strength of fabric, ASTM D-4632	95 lb. min.
UV stability, ASTM D-4355	70 % min.
<b>Note:</b> To provide sufficient strength, fabric shall be sewn together with double stitching.	

- b. Straw Bale installation shall conform to the criteria outlined in the WDNR Conservation Practice Standard (1055) Sediment Bale Barrier (Non-Channel).
- c. Stone weeper installation shall conform to the criteria in WDNR Conservation Practice Standard (1063) Sediment Trap.

## 2. Filter Fabric Barrier Criteria – See Figure 1 Inlet Protection

- a. Inlet protection Type A devices shall be utilized around inlets and unpaved areas until permanent stabilization methods have been established. Type A devices shall be utilized on inlets prior to installation of curb and gutter or pavement, and where safety considerations are not compromised on the site.
- b. Type B shall be utilized after the casting and grate are in place.
- c. Type D shall be utilized in areas where other types of inlet protection are identified as incompatible with roadway and traffic conditions, causing possible safety hazards when ponding occurs at the inlet. Type D shall only be used after castings are in place on top of the inlet boxes.

Type D inlet protection shall conform to the standard drawing as shown in the plans. There shall be a three-inch space between the bag and the sides of the inlet to prevent the inlet sides from blocking the overflow; and shall only be used in inlets deeper than 30 inches from the top of grate to bottom of the inlet. If such clearance is not available, cinch or tie the sides of the bag (with rope or ties) to provide clearance.

## C. Criteria Applicable to the Post-Paving / Curbing Phase of Construction

1. Inlet protection Types B, C, and D are applicable to post paving construction. See Figure 1 Inlet Protection.
  - Type B shall be utilized on inlets without curb box.
  - Type C shall be utilized on street inlets with curb heads. A 1½" x 3½" (37mm by 87 mm) minimum, piece of wood shall be wrapped and secured in the fabric and placed in front of the curb head as shown in the plans. The wood shall not block the entire opening of the curb box and be secured to the grate with wire or plastic ties.
  - Type D

## VI. Considerations

- A. When site conditions allow, inlets should be temporarily closed or sealed to prevent entrance of runoff and sediment.
- B. The best way to prevent sediment from entering the storm sewer system is to stabilize the disturbed area of the site as quickly as possible, preventing erosion and stopping sediment transport at its source.
- C. Storm drain inlet protection consists of several types of inlet filters and traps and should be considered as only one element in an overall erosion control plan. Each type differs in application with selection dependent upon site conditions and inlet type. Not all designs are appropriate in all cases. The user must carefully select a design suitable for the needs and site conditions.
- D. Inlet protection is only as effective as the filter or barrier used around the inlet. Effectiveness decreases rapidly if the inlet protection is not properly maintained. In general, inlet protection provides relatively good removal of coarse and medium-sized soil particles from runoff however, most fine silt and clay particles will pass through the filtering mechanisms.
- E. Properly maintaining inlet protection can be difficult and often inlets can become clogged. Field experience has shown that inlet protection that causes excessive ponding in an area of high construction activity may become so inconvenient that it is simply removed or bypassed, thus transmitting sediment-laden flows unchecked. In such situations, a structure with an adequate overflow mechanism should be utilized instead of simply removing the inlet protection device.
- F. Inlet protection devices can be enhanced by additional excavation to increase the storage capacity around the inlet.
- G. Good construction site housekeeping measures, such as keeping the gutters clean, and street sweeping are important.

## VII. Plans and Specifications

Plans and specifications for installing inlet protection shall be in keeping with this standard and shall describe the requirements for applying the practice to achieve its intended purpose:

- A. Location of inlet protection and type employed
- B. Material spec conforming to standard
- C. All plans, standard detail drawings, or specifications shall include schedule for installation, inspection, and maintenance. The responsible party shall be identified.

## VIII. Operation and Maintenance

- A. Remove inlet protection devices once the contributing drainage area is stabilized with appropriate vegetation or impervious area.
- B. Inlet protection shall be at a minimum inspected weekly and within 24 hours after every precipitation event that produces 0.5 inches of rain or more during a 24-hour period.
- C. Sediment deposits shall be removed and the inlet protection device restored to its original dimensions when the sediment has accumulated between 1/3 to 1/2 the design depth of the device, or when the device is no longer functioning as designed. Removed sediment shall be deposited in a suitable area and stabilized.
- D. Due care shall be taken to ensure sediment does not fall into the inlet and impede the intended function of the device. Any material falling into the inlet shall be removed.

## IX. References

WisDOT “Erosion Control Product Acceptability List” is available online at: <http://www.dot.wisconsin.gov/business/engrserv/pal.htm>. Printed copies are no longer distributed.



## Turbidity Barrier

1069 (09/05)

Wisconsin Department of Natural Resources

Conservation Practice Standard

**Note:** Words in the standard that are shown in italics are described in X. Definitions. The words are italicized the first time they are used.

### I. Definition

A temporary fabric barrier with very low permeability, installed in or near the bed of a waterway or waterbody to minimize sediment transport and is installed parallel to flow. Turbidity barrier cannot be installed perpendicular to a moving channel.

### II. Purposes

The purpose of this practice is to provide sediment containment while construction activities are occurring in or directly adjacent to a waterway or waterbody.

### III. Conditions Where Practice Applies

This practice applies where construction activities intrude or are directly adjacent to a waterway or waterbody. This includes but is not limited to bridge construction, rip rap placement, utility work, streambank restoration, boat launches and dredging.

Use turbidity barriers in conditions with fine soils and flow velocities not exceeding 5 feet per second, unless additional reinforcement is installed.

### IV. Federal, State, and Local Laws

Users of this standard shall be aware of applicable federal, state, and local laws, rules, regulations, or permit requirements governing the use and placement of turbidity barriers. This standard does not contain the text of federal, state, or local laws.

### V. Criteria

This section establishes the minimum standards for design, installation and performance requirements.

- A. Installation – Details of construction not listed in the text shall conform to the pertinent requirements of Figures 1 and 2.
  1. The barrier shall be installed before construction activities are initiated in, or adjacent to the waterway or waterbody. Install the turbidity barrier as close to the construction as practical. The barrier shall remain in place and be maintained until the construction activity is completed and the disturbed area *stabilized*<sup>1</sup>.
  2. The ends of the barrier shall be securely anchored and keyed into the shoreline to fully enclose the area where sediment may enter the water.
  3. Driven steel posts shall be used to hold the barrier in position. The maximum spacing between posts shall be 10 feet. When barrier height exceeds 8 feet, post spacing may need to be decreased.
 

When bedrock prevents the installation of posts, float devices may be used. Flotation devices shall be flexible, buoyant units contained in an individual flotation sleeve or collar attached to the turbidity barrier. Use solid expanded polystyrene logs or equivalent having a 49 square inch minimum end area. Do not use polystyrene beads or chips. Buoyancy provided by the flotation devices shall be sufficient to support the weight of the turbidity barrier and maintain a freeboard of at least three inches above the water surface. Refer to Figure 1.
  4. The barrier and steel posts shall extend from the bottom of the waterway or waterbody to an elevation 2 feet above the anticipated high water level during the time of year and duration the barrier will be in place. The elevation shall not exceed the top of bank.
  5. Ballast shall be used to hold the barrier in a vertical position. Bottom load lines shall consist of a chain incorporated into the bottom hem of the screen, of sufficient weight to serve as ballast to hold the screen in a vertical position. Additional anchorage shall be provided if necessary.
  6. Danger buoys shall be used as directed by the Coast Guard or DNR permit when working in navigable waters.
  7. Turbidity barriers shall be installed parallel to the direction of flow and shall not be installed across channels.

**B. Material**

1. Reusable components of the turbidity barrier system shall be clean and free of potential exotic species. Fabric cannot be reused.
2. Top load lines shall consist of 5/16 inch steel cable.
3. Fabric shall be selected according to the specifications in Table 1.

**Table 1**

<b>Requirement</b>	<b>Method</b>	<b>Value</b>
Min. grab tensile strength	ASTM D 4632	200 lb (890 N)
Min. puncture strength	ASTM D 4833	90 lb (400 N)
Maximum permeability	ASTM D 4491	= $1 \times 10^{-7}$ cm/s
Min. ultraviolet stability	ASTM D 4355	70%

Source: WisDOT Spec 628.2.10.

**VI. Considerations**

- A. The 5 feet per second flow velocity specified in Section III can be the base flow of the stream or the base flow plus the addition of storm event runoff. Base flow can be used alone for short term projects (typically one day duration, i.e. culvert installation) when the chance of precipitation is low. Longer term projects (i.e. bridge work) should consider storm flow in addition to base flow (typically the two year event).
- B. If the current exceeds 5 feet per second, other methods to divert flow away from the turbidity barrier such as temporary concrete traffic barriers, coffer dams, pumping, or sheet piling should be considered.
- C. Sediment that has been settled out by the turbidity barrier should only be removed if so directed by the regulatory authority because re-suspension of sediment will likely occur during the removal process. Use of polymers may help prevent resuspension of sediment. See WDNR Technical Standard 1051 Sediment Control Water Application of Polymers for further guidance.
- D. Turbidity barriers are meant to manage sediment in the waterbody. The best way to prevent sediment from entering the waterbody is through the implementation of effective upland erosion control, stopping sediment transport at its source.
- E. Turbidity barriers should not be used to reduce the conveyance capacity of the channel. An example is use on bridge projects where the turbidity barrier is installed adjacent to each abutment simultaneously.
- F. Turbidity barriers may be installed on the banks of a waterway or waterbody if higher water levels are anticipated during construction.

**VII. Plans and Specifications**

Plans and specifications for installing a turbidity barrier shall be in keeping with this standard and attached detail drawing and shall describe the requirements for applying the practice to achieve its intended purpose:

- A. Location of turbidity barrier.
- B. Material specification conforming to standard.
- C. All plans, standard detail drawings, or specifications shall include schedule sequence or notes for installation, inspection, and maintenance. The responsible party shall be identified.

**VIII. Operation and Maintenance**

- A. Turbidity barriers shall be inspected daily and repaired if necessary.
- B. Turbidity barriers shall not be removed until the water behind the barrier has equal or greater clarity than the waterway or waterbody.
- C. Care shall be taken when removing the barrier to minimize the release or re-suspension of accumulated sediment.

- D. To prevent the spread of exotic species turbidity barriers shall not be reused on other sites. Buoys and chains can be reused but shall be either disinfected with vinegar or cleaned with hot water greater than 104 deg. F then allowed to completely dry for a minimum period of five days. If there are any questions about the occurrence of zebra mussels, Eurasian water-milfoil, or other aquatic invasive species in a waterbody that you are working in, or intend to work in, contact your local DNR staff.

**IX. References**

WisDOT Facilities Development Manual: Chapter 10, Section 10, Subject 45, Turbidity Barrier

**X. Definitions**

*Stabilized* (V.A.1): Means that all land disturbing construction activities at the construction site have been completed, and that a uniform perennial vegetative cover has been established with a density of at least 70% of the cover for the unpaved areas and areas not covered by permanent structures, or that employ equivalent stabilization measures.

(Figures are available on DNR website.)

Figure 1. Turbidity Barrier Placement Details

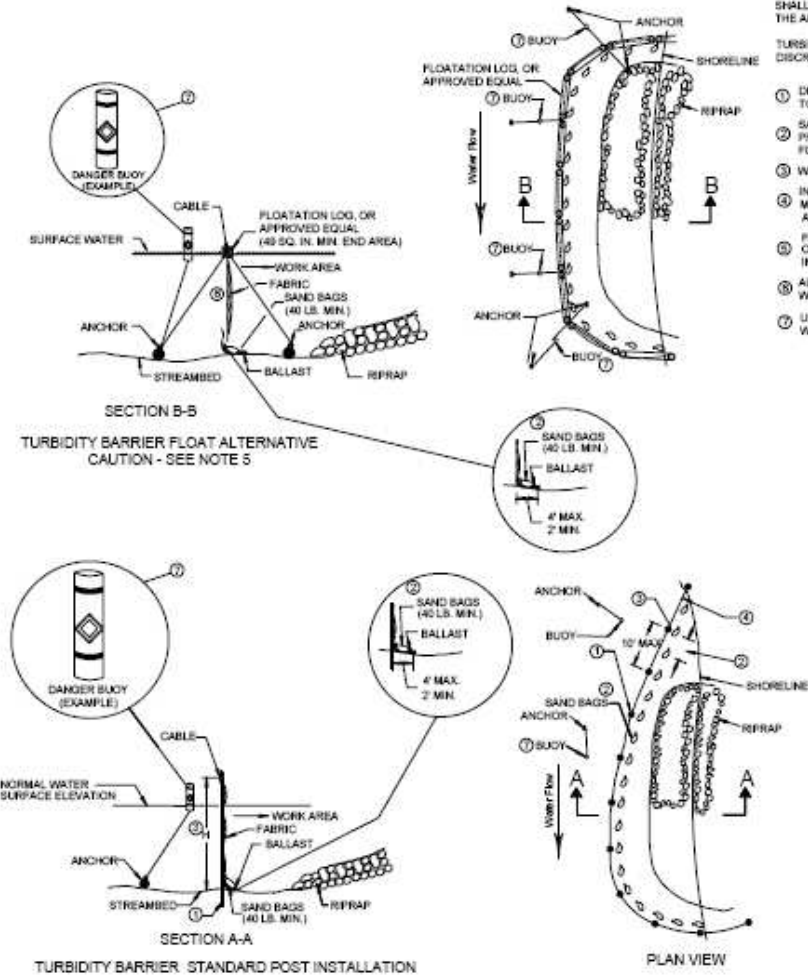

GENERAL NOTES

DETAILS OF CONSTRUCTION, MATERIALS AND WORKMANSHIP NOT SHOWN ON THIS DRAWING SHALL CONFORM TO THE PERTINENT REQUIREMENTS OF THE STANDARD AND THE APPLICABLE SPECIAL PROVISIONS

TURBIDITY BARRIER MAY BE REMOVED AT THE ENGINEER OR PROJECT MANAGERS DISCRETION, WHEN PERMANENT EROSION CONTROL MEASURES HAVE BEEN ESTABLISHED

- ① DRIVEN STEEL POSTS, PIPES, OR CHANNELS, LENGTH SHALL BE SUFFICIENT TO SECURELY SUPPORT BARRIER AT HIGH WATER ELEVATIONS.
- ② SANDBAGS TO BE USED AS ADDITIONAL BALLAST WHEN ORDERED BY THE ENGINEER OR PROJECT MANAGER TO MEET ADVERSE FIELD CONDITIONS. SPACE AS APPROPRIATE FOR SITE CONDITIONS.
- ③ WHEN BARRIER HEIGHT, H, EXCEEDS 8 FT., POST SPACING MAY NEED TO BE DECREASED.
- ④ IN WATERWAYS SUBJECT TO FLUCTUATING WATER ELEVATIONS, PROVISIONS SHOULD BE MADE TO ALLOW THE WATER TO EQUALIZE ON EACH SIDE OF THE BARRIER. THIS MAY BE ACCOMPLISHED BY LEAVING A PORTION OF THE BARRIER OPEN ON THE UPSTREAM END.
- ⑤ FLOAT ALTERNATIVE WILL ONLY BE ALLOWED WITH WRITTEN APPROVAL OF THE ENGINEER OR PROJECT MANAGER, AND IS MEANT FOR LOCATIONS WHERE BED ROCK PREVENTS THE INSTALLATION OF POSTS.
- ⑥ ALLOW SUFFICIENT SLACK VERTICALLY AND HORIZONTALLY SO THAT SEDIMENT BUILD UP WILL NOT SEPARATE OR LOWER THE TURBIDITY BARRIER.
- ⑦ USE AS DIRECTED BY COAST GUARD OR DNR PERMIT WHEN WORKING IN NAVIGABLE WATERWAYS.

NOT TO SCALE

This drawing based on Wisconsin Department of Transportation Standard Detail Drawing 8 E 11-2.

FIGURE 2. TURBIDITY BARRIER DETAIL SHOWING TYPICAL PLACEMENT AT STRUCTURES

GENERAL NOTE

FLOAT ALTERNATIVE WILL ONLY BE ALLOWED WITH WRITTEN APPROVAL OF THE ENGINEER OR PROJECT MANAGER AND IS MEANT FOR LOCATIONS WHERE BEDROCK PREVENTS THE INSTALLATION OF POSTS.

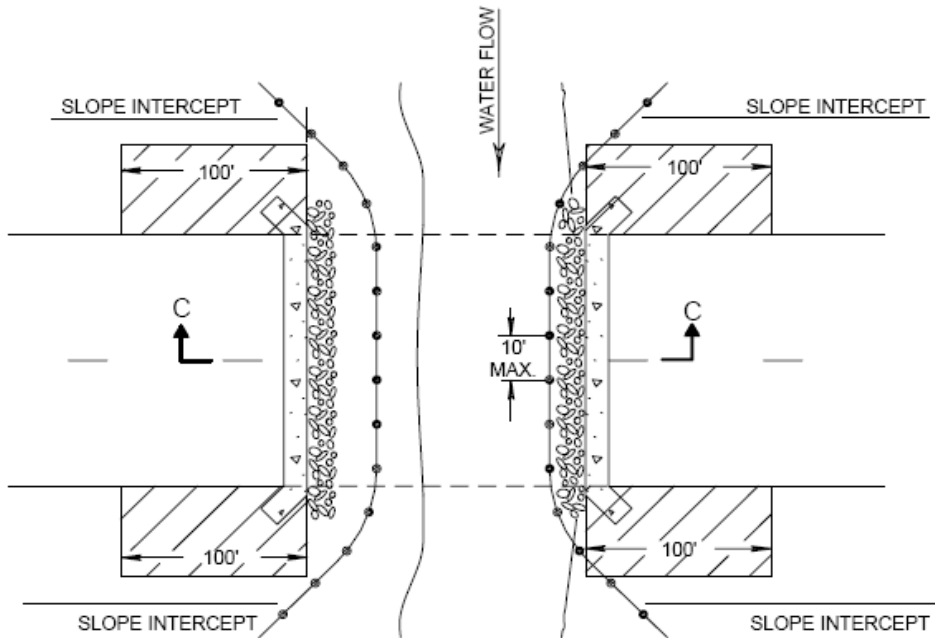

PLAN VIEW

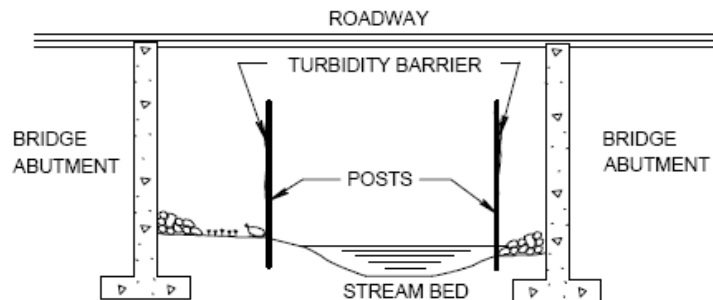

SECTION C-C

NOT TO SCALE

This Drawing is Based on Wisconsin Department of Transportation Standard Detail Drawing 8 E 11-2.

## Vegetative Buffer For Construction Sites

1054 (05/03)

Wisconsin Department of Natural Resources

Conservation Practice Standard

**Note:** Words in the standard that are shown in italics are described in IX. Definitions. The words are italicized the first time they are used.

### I. Definition

An area of *dense vegetation*<sup>1</sup> intended to slow runoff and trap sediment. Vegetative Buffers are commonly referred to as filter or buffer strips.

### II. Purpose

The purpose of this practice is to remove sediment in *sheet flow* by velocity reduction.

### III. Conditions Where Practice Applies

This practice applies to areas where sediment delivery is in the form of *sheet and rill erosion* from disturbed areas.

### IV. Federal, State, and Local Laws

Users of this standard shall be aware of applicable federal, state, and local laws, rules, regulations, or permit requirements governing the use and placement of a vegetative buffer. This standard does not contain the text of federal, state, or local laws.

### V. Criteria

This section establishes the minimum standards for design, installation and performance requirements.

Vegetative Buffer

Disturbed Area ↓ **Direction of Flow** ↓

↑

Width

↓

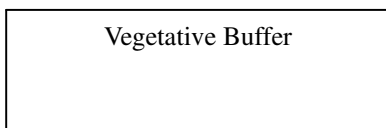

← Length →

- A. The vegetative buffer shall be located along the entire length of the down slope edge of the entire disturbed area for which the practice is being applied.
- B. The vegetative buffer shall be located on the contour.
- C. The width of the vegetative buffer shall have slopes less than 5%.
- D. The disturbed area draining to the vegetative buffer shall have slopes of 6% or less.
- E. The vegetative buffer shall have a minimum *width* of 25 feet. 25 feet is adequate for disturbed areas up to 125 feet upslope from the vegetative buffer. An additional one foot of width shall be added to the buffer for every 5 feet exceeding 125 feet upslope of the disturbed area draining to the vegetative buffer.
- F. To minimize compaction and destruction of the vegetative cover, designate the vegetative buffer as an area of no disturbance. Construction equipment shall be excluded from the designated area. Vegetative buffers shall be clearly shown on plans and marked in the field.
- G. Vegetative buffers shall be densely vegetated prior to upslope soil disturbance.

**VI. Considerations**

- A. Maintaining sheet flow is critical to the function of a vegetative buffer. In some conditions, a *level spreader* may need to be constructed at the upslope side of the vegetative buffer to minimize concentrated flow.
- B. Vegetative buffers may require large land areas compared to other erosion control practices.
- C. Trees should not be cut down to establish a vegetative buffer. Other erosion control measures are preferred.

**VII. Plans and Specifications**

- A. Plans and specifications for vegetative buffers shall be in keeping with this standard and shall describe the requirements for applying the practice to achieve its intended purpose. The plans and specifications shall address the following:
  1. Location of vegetative buffer.
  2. Limits and slopes of disturbed area and any additional contributory drainage area.
  3. Dimensions and slope of vegetative buffer.
- B. All plans, standard detail drawings, or specifications shall include schedule for installation, inspection, and maintenance. The responsible party shall be identified.

**VIII. Operation and Maintenance**

- A. Vegetative buffers shall be inspected for proper distribution of flows, sediment accumulation and signs of rill formation. Vegetative buffers shall at a minimum be inspected weekly and within 24 hours after every precipitation event that produces 0.5 inches of rain or more during a 24-hour period.
- B. If the vegetative buffer becomes silt covered, contains rills, or is otherwise rendered ineffective, other perimeter sediment control measures shall be installed. Eroded areas shall be repaired and stabilized. Repair shall be completed as soon as possible with consideration to site conditions.
- C. A stand of dense vegetation shall be maintained to a height of 3–12 inches.
- D. Prior to land disturbance the perimeter of vegetative buffers shall be flagged or fenced to prevent equipment from creating ruts, compacting the soil and to prevent damage to vegetation.

**IX. Definitions**

*Dense vegetation* (I): is defined as an existing stand of 3–12 inch high grassy vegetation that uniformly covers at least 90 % of a representative 1 square yard plot. Woody vegetation shall not be counted for the 90% coverage. No more than 10% of the overall buffer can be comprised of woody vegetation.

*Level Spreader* (VI.A): Level spreaders disperse flows over a wide area, dissipating the energy of the runoff and creating sheet flow. Common types of level spreaders are weirs and stone trenches.

*Sheetflow* (II): Sheet flow is over plane surfaces, where runoff water flows in a thin uniform sheet across the land before it collects in a concentrated flow.

*Sheet and Rill Erosion* (III): Sheet and rill erosion is the removal of soil by the action of rainfall and shallow overland runoff. It is the first stage in water erosion. As flow becomes more concentrated rills occur. As soil detachment continues or flow increases, rills will become wider and deeper.

*Width* (V.E): Is measured in the direction of flow.

**s. SPS 321.16****Frost-Protected Shallow Footings**

In lieu of frost walls, the code recognizes frost-protected shallow foundations designed per ASCE 32, "Design and Construction of Frost-Protected Shallow Foundations". The department also recognizes the similar design standards of U.S.HUD "Design Guide for Frost-Protected Shallow Foundations", available for free download from [www.huduser.org/publications/dstech/desguide.html](http://www.huduser.org/publications/dstech/desguide.html) and summarized below. Consult it or the ASCE standard for full design and installation information, including a more flexible, detailed design method that should be used for heated buildings with attached, unheated garages.

Note that both standards offer design methods for both heated and unheated buildings. For heated buildings, the designs rely upon containing the building's heat under the footings to avoid frost heaving. In the case of unheated buildings, the designs rely upon containing the earth's natural warmth under the footings and slab by the use of more extensive insulation. (For both design approaches, compliance with their frost-protection requirements is not necessarily the same as compliance with the ch. SPS 322 Energy Conservation standards for slab-on-grade designs.)

Because the simplified heated building design methods rely upon buildings, including attached garages, with at least a 63 degree internal temperature, it is important the building designer consult with the owner regarding their intended use. Even if the initial owner plans to keep the building heated throughout the winter, future owners may use it otherwise. Therefore, the designer should be sure to communicate the operational needs of the building through means such as building placarding, notating the Rescheck Energy Report, and/or recording relevant information on the property deed. **Failure to do so may cause severe structural damage to the building if future owners do not keep the building heated.**

## Unheated Building Design Minimum Ground Insulation Requirements<sup>1</sup>

Air Freezing Index (°F-days) <sup>3</sup> (see map)	D <sub>g</sub> —Insulation Width from Edge of Foot- ing <sup>4, 5</sup>	Mean Annual Temperature <sup>2, 6</sup> (see map)			Minimum Footing Depth <sup>7, 8</sup>	
		38	40	≥41	D— Concrete & Insulation Depth	G—Granular Base Thickness
2,250 or less	63"	R-13.6	R-11.4	R-10.2	10"	6"
2,251–3,000	79"	R-18.2	R-15.3	R-14.2	10"	6"
3,001–3,750	91"	R-22.7	NA	NA	10"	6"

1 Also see s. SPS 322.33 for additional slab-edge insulation requirements.

2 Units are degrees Fahrenheit. See estimate provided on Mean Annual Temperature Contour Map.

3 Air freezing index shall be based on maximum year expected for a 100-year return period. See estimate provided on AFI Contour Map.

4 Ground insulation to the building interior can be extended beneath the entire slab where it is desired to protect the entire slab from frost heave action.

5 Ground insulation to the building interior can be in one horizontal plane (as shown in the detail) and covered with non frost-susceptible fill or the insulation maybe placed directly beneath the slab.

6 Insulation thickness recommendations are for extruded polystyrene (XPS) insulation.

7 The minimum depth of concrete footing and horizontal insulation is 10". A 6" drainage layer is required under the insulation.

8 Insulation placed directly beneath the footing shall be Type IV or Type VI XPS in accordance with ASTM C578. Maximum deadload placed on the Type IV insulation shall be 1200 pounds/square foot. Maximum deadload placed on Type VI shall be 1900 psf.

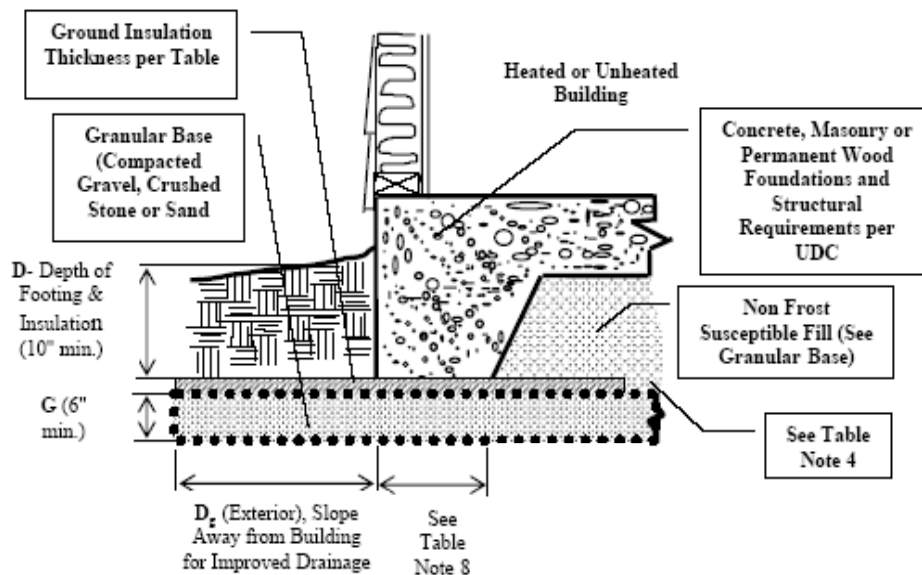

## Heated Building Design

### Minimum Insulation Requirements for Frost-Protected Footings in Heated Buildings<sup>1</sup> (Simplified Method)

Air Freezing Index (°F days) <sup>2</sup> (see map)	Vertical Insulation R-Value <sup>3, 4</sup>	Horizontal Insulation R-Value <sup>3, 5</sup>		Horizontal Insulation Dimensions per Figure Below (inches)			Minimum Footing Depth (inches)
		Along walls	At corners	A	B	C	
2,000 or less	5.6	NR	NR	NR	NR	NR	14
<b>2,500 or less</b>	<b>6.7</b>	<b>1.7</b>	<b>4.9</b>	<b>12</b>	<b>24</b>	<b>40</b>	<b>16</b>
3,000 or less	7.8	6.5	8.6	12	24	40	16
3,500 or less	9.0	8.0	11.2	24	30	60	16

1 Insulation requirements are for protection against frost damage in heated buildings. Greater values may be required to meet energy conservation standards. Interpolation between values is permissible.

2 See AFI Contour Map for Air Freezing Index values.

3 Insulation materials shall provide the stated minimum R-values under long-term exposure to moist, below-ground conditions in freezing climates. The following R-values shall be used to determine insulation thicknesses required for this application: Type II expanded polystyrene – 2.4R per inch; Types IV, V, VI, VII extruded polystyrene – 4.5R per inch; Type IX expanded polystyrene – 3.2R per inch. NR indicates that insulation is not required.

4 Vertical insulation shall be expanded polystyrene insulation or extruded polystyrene insulation.

5 Horizontal insulation shall be extruded polystyrene insulation.

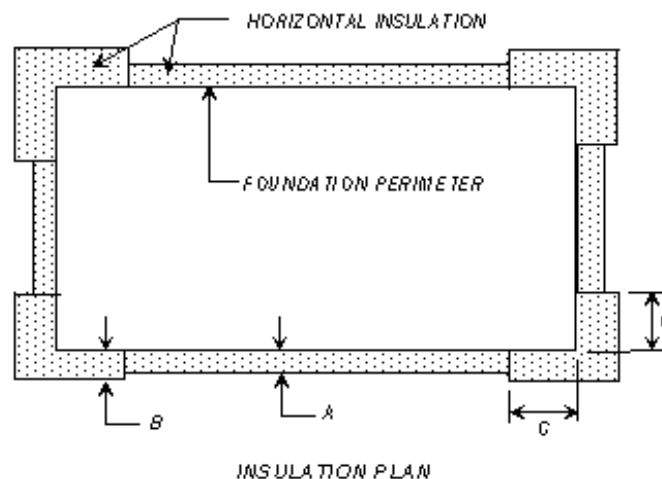
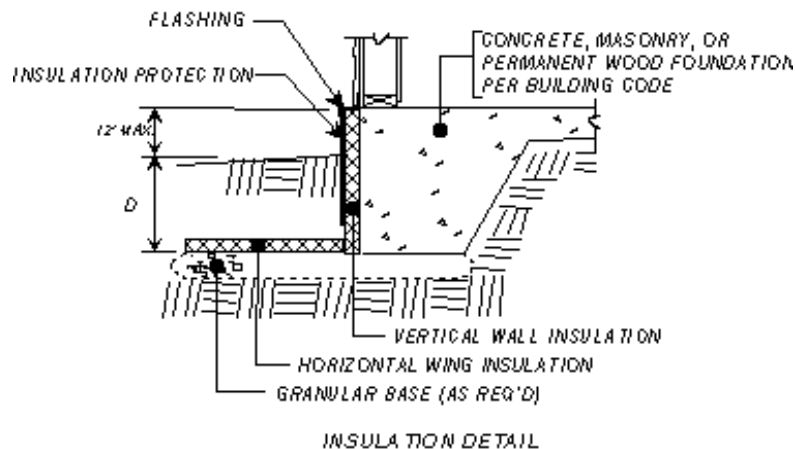

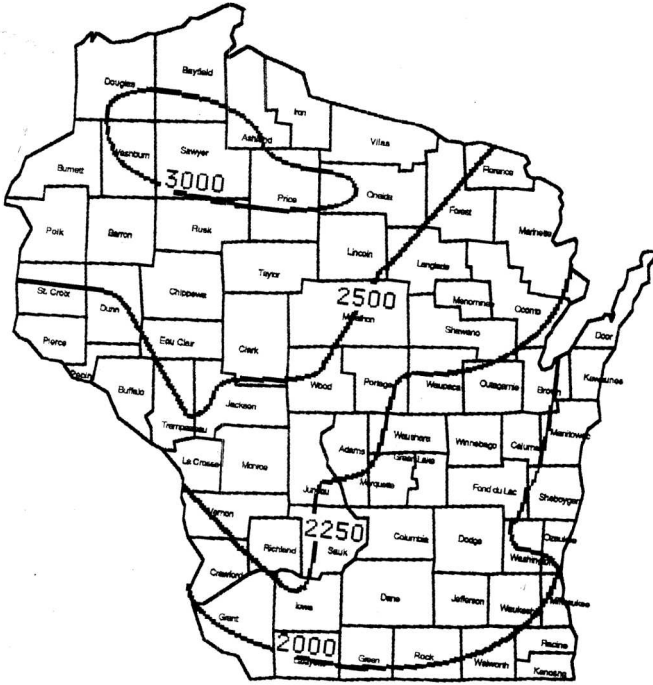

**Air-Freeze Index Contour Map**

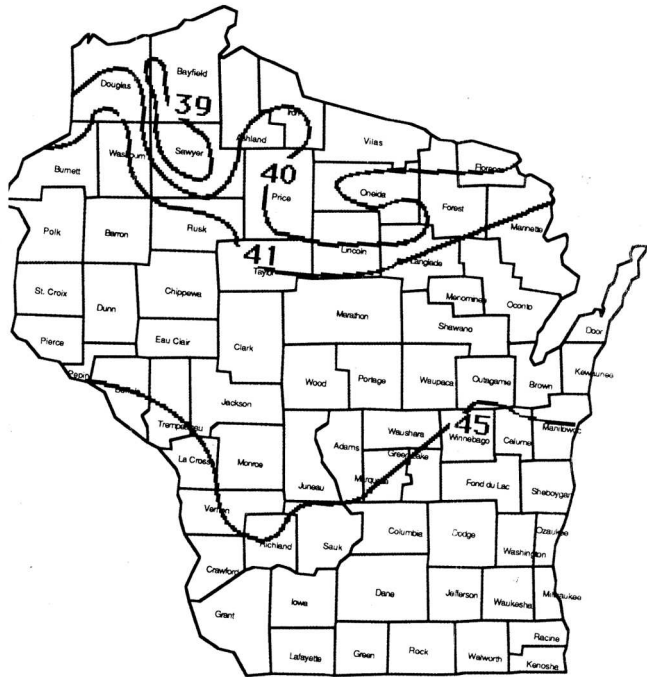

**Mean Annual Temperature Contour Map**

**321.40 (1) (h), HUD Roof-Load Zone Map**

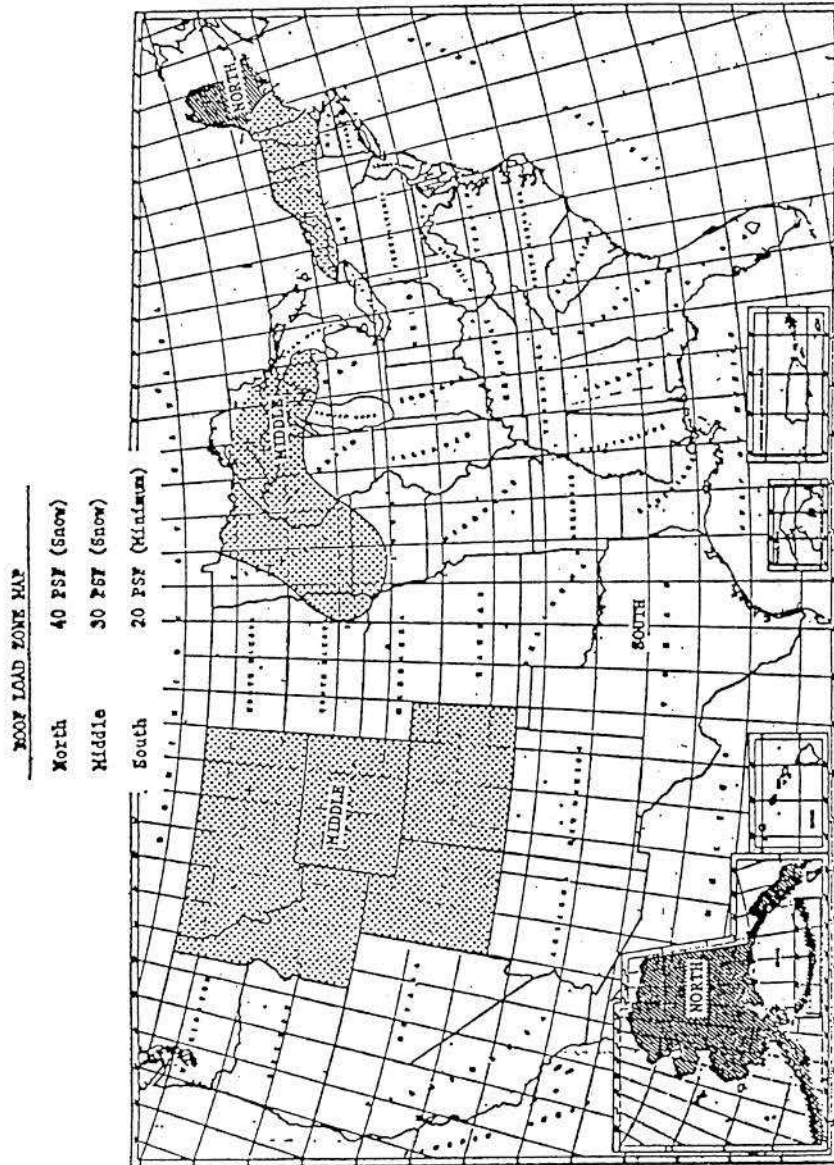

### Section SPS 322.33 Slab-On-Grade Insulation Details

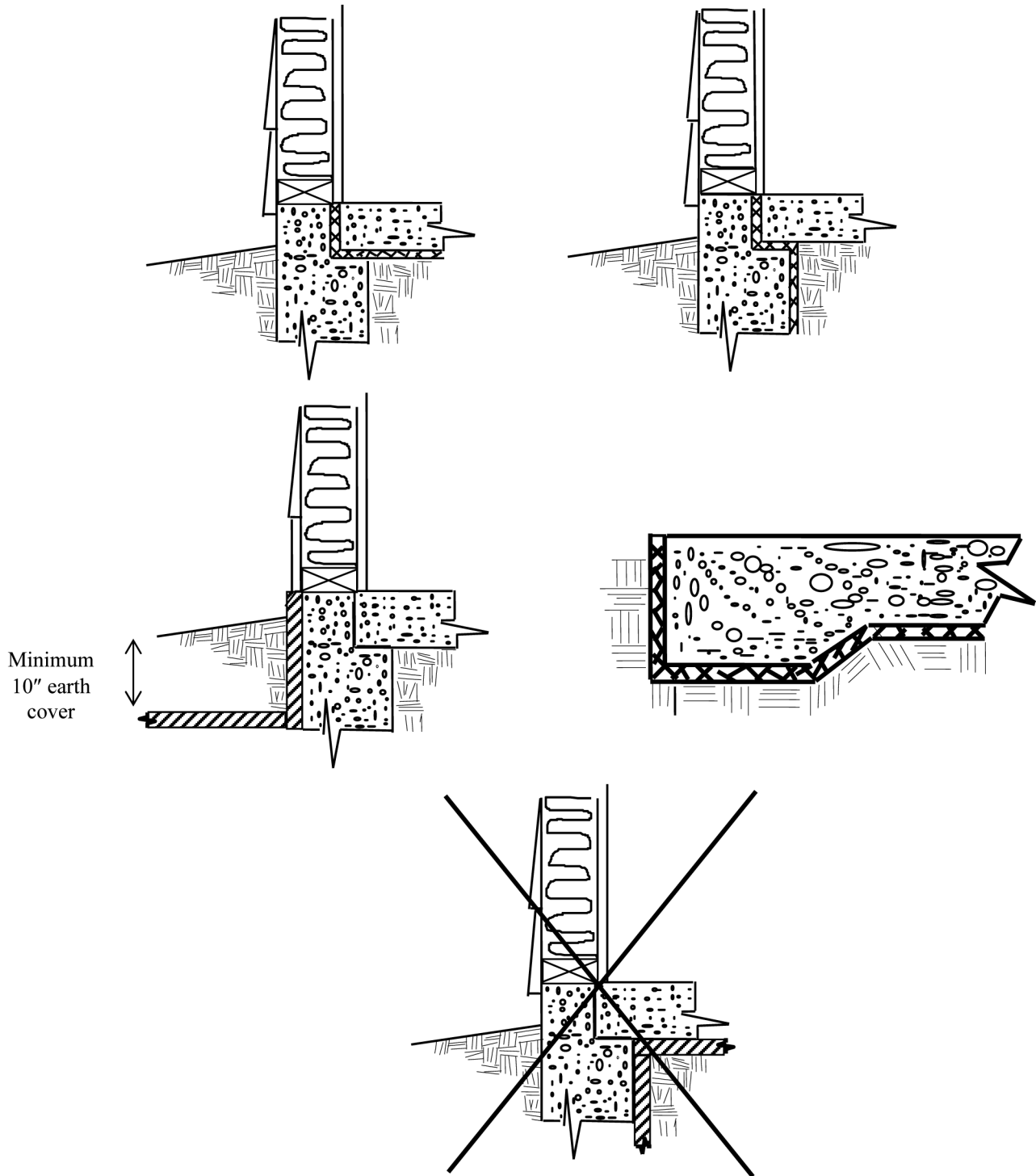

Insulation shall extend vertically and horizontally for a total of 48". In all cases the insulation shall insulate to the top edge of the floor perimeter. The last diagram is not an acceptable method. Additional insulation may be necessary to comply with the structural stability requirements of s. SPS 321.16 for frost-protected shallow foundations.

**SPS 323.02 (1) Outdoor Design Temperatures**

Zone 1	25° below zero F
Zone 2	20° below zero F
Zone 3	15° below zero F
Zone 4	10° below zero F

